

X 331

Excavator

Service Manual

(S/N 511920001 & Above)

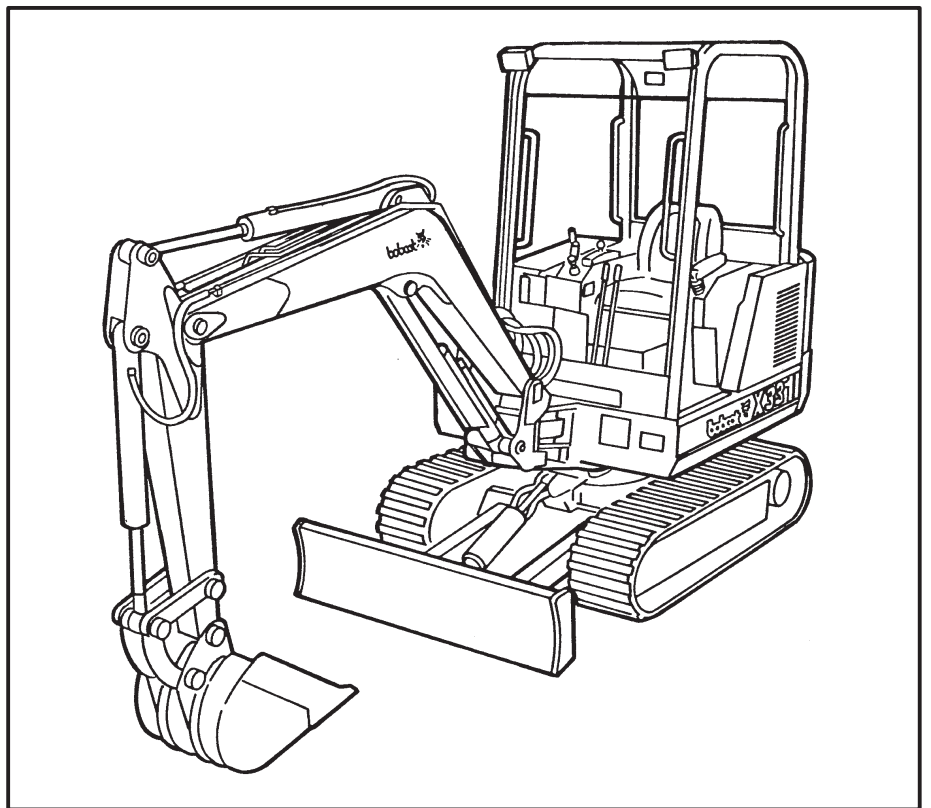

MELROE
INGERSOLL-RAND

6722918(5-94)

Printed in U.S.A.

 **bobcat**[®]

© Melroe Company 1994

MAINTENANCE SAFETY



WARNING

Instructions are necessary before operating or servicing machine. Read and understand the Operation & Maintenance Manual, Operator's Handbook and signs (decals) on machine. Follow warnings and instructions in the manuals when making repairs, adjustments or servicing. Check for correct function after adjustments, repairs or service. Untrained operators and failure to follow instructions can cause injury or death.

W-2003-0903



Safety Alert Symbol: This symbol with a warning statement, means: "Warning, be alert! Your safety is involved!" Carefully read the message that follows.

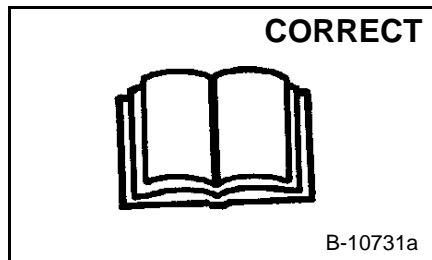

B-10731a

⚠ Never service the Bobcat Hydraulic Excavator without instructions.

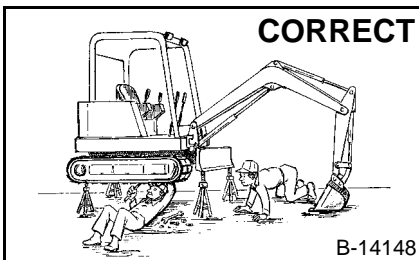

B-14148

⚠ Use the correct procedure to lift and support the excavator.
⚠ Always lift the blade fully before installing jackstands.

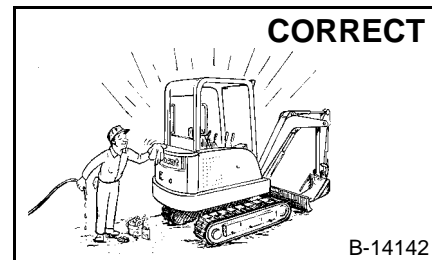

B-14142

⚠ Cleaning and maintenance are required daily.

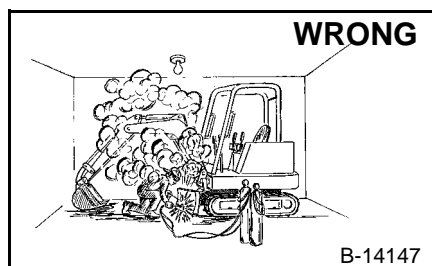

B-14147

⚠ Have good ventilation when welding or grinding painted parts.
⚠ Wear dust mask when grinding painted parts. Toxic dust and gas can be produced.



B-14141

⚠ Vent exhaust to outside when engine must be run for service.
⚠ Exhaust system must be tightly sealed. Exhaust Fumes can kill without warning.

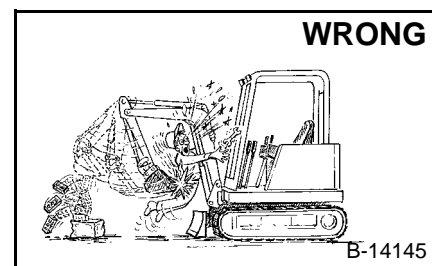

B-14145

⚠ Always lower the bucket and blade to the ground before doing any maintenance.
⚠ Never modify equipment or add attachments not approved by Bobcat Company.

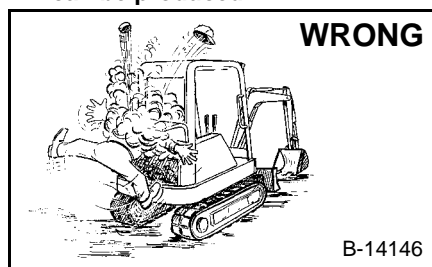

B-14146

⚠ Stop, cool and clean engine of flammable materials before checking fluids.
⚠ Never service or adjust machine with the engine running unless instructed to do so in the manual.
⚠ Avoid contact with leaking hydraulic fluid or diesel fuel under pressure. It can penetrate the skin or eyes.
⚠ Never fill fuel tank with engine running, while smoking or when near open flame.

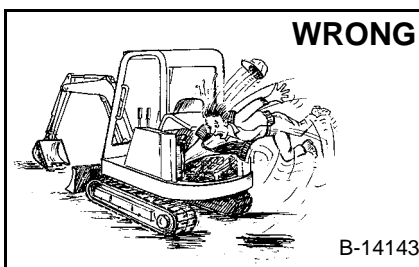

B-14143

⚠ Keep body, jewelry and clothing away from moving parts, electrical contact, hot parts and exhaust.
⚠ Wear eye protection to guard from battery acid, compressed springs, fluids under pressure and flying debris when engines are running or tools are used. Use eye protection approved for type of welding.
⚠ Keep rear door closed except for service. Close and latch door before operating the excavator.



B-6589

⚠ Lead-acid batteries produce flammable and explosive gases.
⚠ Keep arcs, sparks, flames and lighted tobacco away from batteries.
⚠ Batteries contain acid which burns eyes or skin on contact. Wear protective clothing. If acid contacts body, flush well with water. For eye contact flush well and get immediate medical attention.

Maintenance procedures which are given in the Operation & Maintenance Manual can be performed by the owner/operator without any specific technical training. Maintenance procedures which are **not** in the Operation & Maintenance Manual must be performed **ONLY BY QUALIFIED BOBCAT SERVICE PERSONNEL**. Always use genuine Bobcat replacement parts. The Service Safety Training Course is available from your Bobcat dealer.

CONTENTS

SAFETY INSTRUCTIONS	i
SERIAL NUMBER LOCATIONS	ii
DELIVERY REPORT	ii
HYDRAULIC EXCAVATOR IDENTIFICATION	iii
PREVENTIVE MAINTENANCE	1-1
HYDRAULIC SECTION	2-1
DRIVE SECTION	3-1
UPPER WORKS & SWING SECTION	4-1
MAIN FRAME & TRACKS	5-1
ELECTRICAL SYSTEM	6-1
ENGINE SERVICE	7-1
TECHNICAL DATA	8-1

**PREVENTIVE
MAINTENANCE**

**HYDRAULIC
SECTION**

**DRIVE
SECTION**

**UPPER WORKS
& SWING
SECTION**

**MAIN FRAME
& TRACKS**

**ELECTRICAL
SYSTEM**

**ENGINE
SERVICE**

**TECHNICAL
DATA**

FOREWORD

This manual is for the Bobcat hydraulic excavator mechanic. It provides necessary servicing and adjustment procedures for the hydraulic excavator and its component parts and systems. Refer to the Operation & Maintenance Manual for operating instructions, starting procedure, daily checks, etc.

A general inspection of the following items must be made after the hydraulic excavator has had service or repair:

1. Check that the ROPS/TOPS/FOGS is in good condition and is not modified.

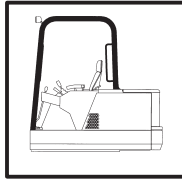

2. Check that ROPS/TOPS mounting hardware is tightened and is Melroe approved.

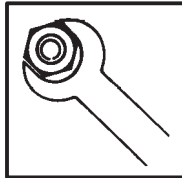

3. The seat belt must be correctly installed, functional and in good condition.

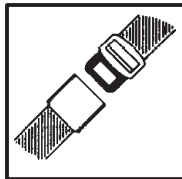

4. Inspect for loose or broken parts or connections.

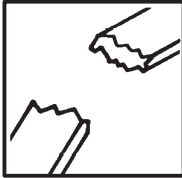

5. Machine signs must be legible and in the correct location.

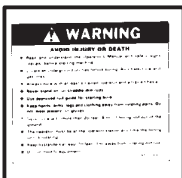

6. Steering levers, control levers and foot pedals must return to neutral. Check that foot pedals lock and control lever locks are in working condition.

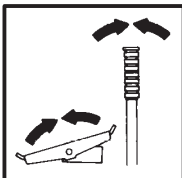

7. Inspect the air cleaner for damage or leaks. Check the condition of the element.

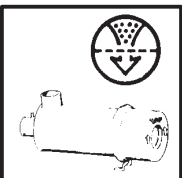

8. Check the electrical charging system.

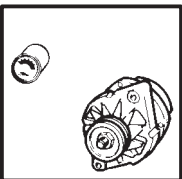

9. Safety treads must in good condition.

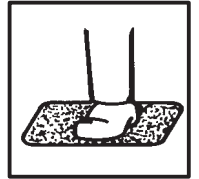

10. Check for correct function of indicator lamps.

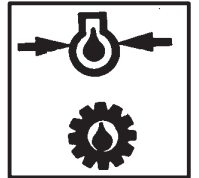

11. Check hydraulic fluid level, engine oil level and fuel supply.

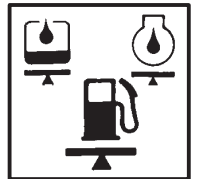

12. Inspect for fuel, oil or hydraulic fluid leaks.



13. Lubricate the hydraulic excavator.



14. Check the condition of the battery and cables.

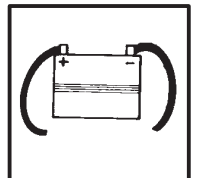

Recommend to the owner that all necessary corrections be made before the machine is returned to service.

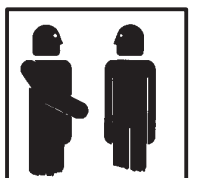

SAFETY INSTRUCTIONS

WARNING

Instructions are necessary before operating or servicing machine. Read Operation & Maintenance Manual, Handbook and signs (decals) on machine. Follow warnings and instructions in the manuals when making repairs, adjustments or servicing. Check for correct function after adjustments, repairs or service. Failure to follow instructions can cause injury or death.

W-2003-0797

The following publications provide information on the safe use and maintenance of the loader and attachments:

- The Delivery Report is used to assure that complete instructions have been given to the new owner and that the machine is in safe operating condition.
- The Operation & Maintenance Manual delivered with the excavator gives operating information as well as routine maintenance and service procedures. It is a part of the excavator and must stay with the machine when it is sold.
- The excavator has machine signs (decals) which instruct on the safe operation and care. The signs and their locations are shown in the Operation & Maintenance Manual. Replacement signs are available from your Bobcat Excavator dealer.
- The CIMA Safety Manual delivered with the excavator gives information for safe operating and standard signals.
- The Service Manual and Parts Manual are available from your dealer for use by mechanics to do shop-type service and repair work.



Safety Alert Symbol: This Safety Symbol is used for important safety messages. When you see this symbol follow the safety message to avoid personal injury or death.

- Wear tight fitting clothing and any other required safety apparel when operating or servicing the excavator.
- Wear safety glasses when maintaining or servicing the excavator.
- Exhaust gases can kill, vent engine exhaust outdoors.
- Know where fire extinguishers and first aid kits are located and how to use them.
- Do not run the excavator where exhaust, arcs, sparks or hot components can contact flammable material, explosive dust or gases.
- Check fuel and hydraulic tubes, hoses and fittings for damage and leakage. Never use open flame or bare skin to check for leaks. Tighten or replace any parts that show leakage. Always clean fluid spills. Do not use gasoline or diesel fuel for cleaning parts. Use commercial nonflammable solvents.
- Do not use ether or starting fluids on an engine that has glow plugs. These starting aids can explode and injure you.
- Clean the excavator before doing any welding. Cover rubber hoses, battery and all other flammable parts. Keep a fire extinguisher near the excavator when welding.
- Have good ventilation when welding or grinding painted parts. Wear a dust mask when grinding painted parts. Toxic dust or gas can be produced.
- Stop the engine and let it cool before adding fuel. No smoking!
- Use the procedure in this manual for installing, connecting and jump starting batteries.

SERIAL NUMBER LOCATIONS

Always use the serial number of the machine when requesting service information or when ordering parts. Early or later models (identification made by serial number) may use different parts, or it may be necessary to use a different procedure in doing a specific service operation.

HYDRAULIC EXCAVATOR SERIAL NUMBER

The excavator serial number is on the front of the machine frame, to the left of the boom [A].

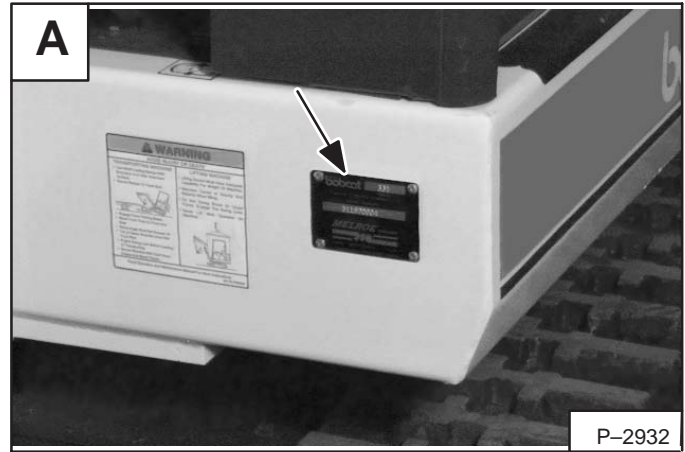

ENGINE SERIAL NUMBER

The engine serial number is located on the engine block, near the fuel injection pump [B].

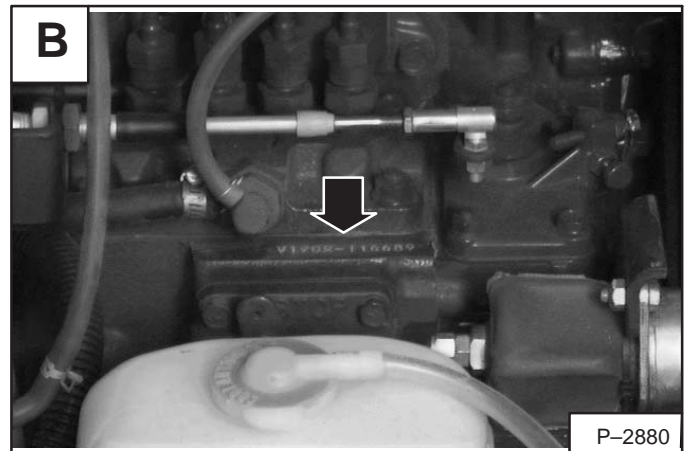

DELIVERY REPORT

All Delivery Report items must be explained to the owner/operator by the dealer. The dealer is to fill out the form and the owner/operator signs the form to indicate his understanding [C].

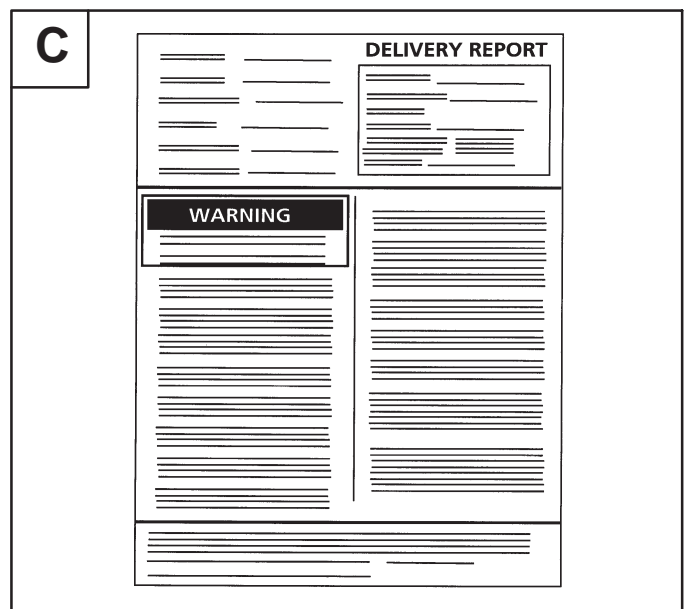
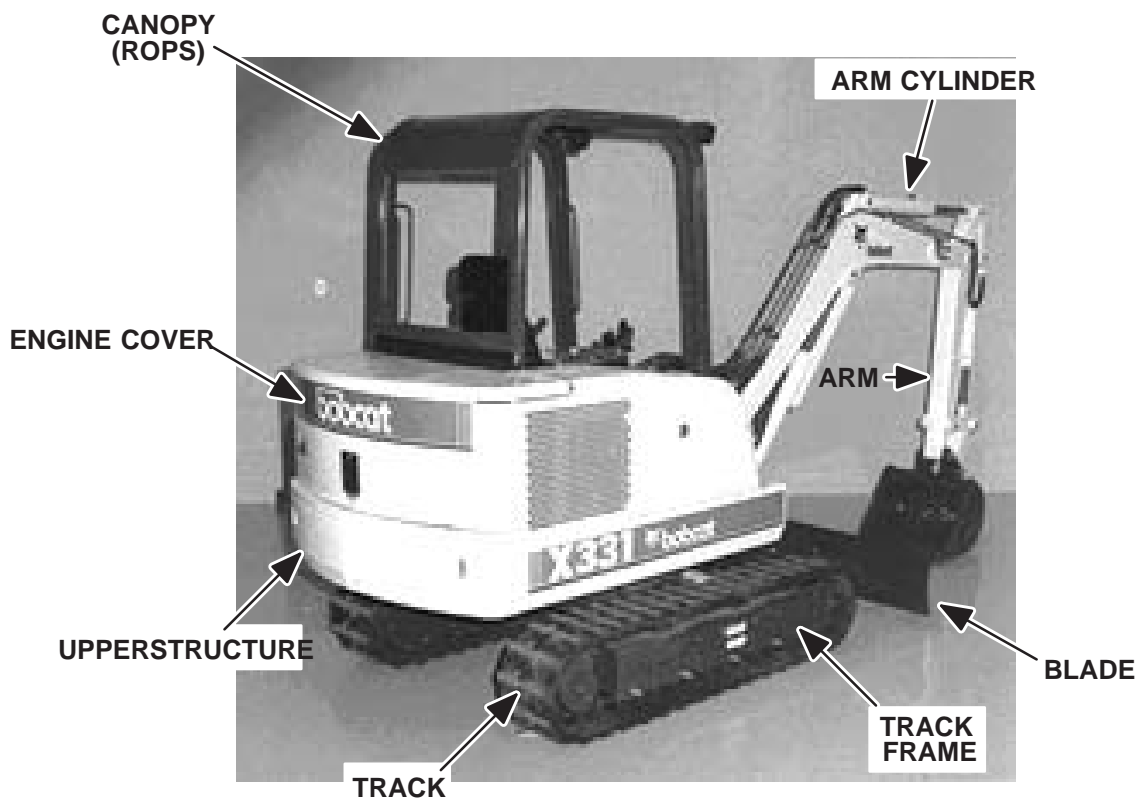
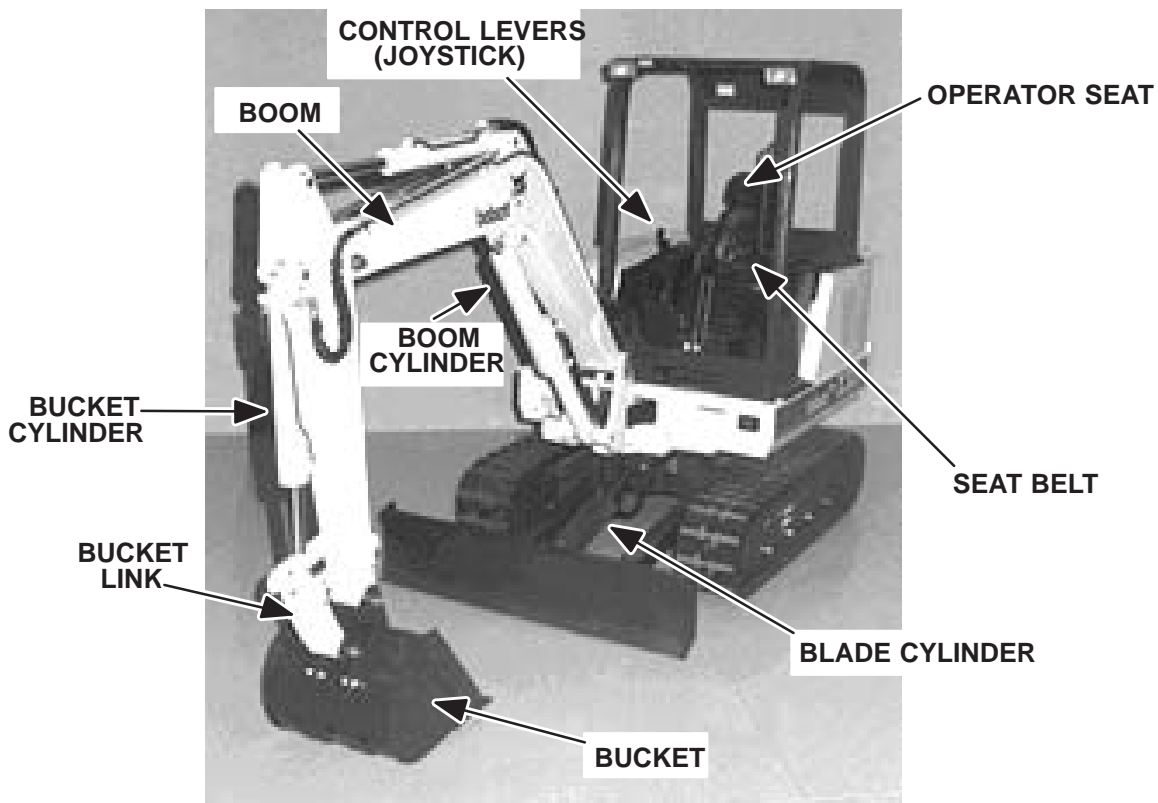

Image C shows a delivery report form. The form is divided into several sections. At the top right is a section titled 'DELIVERY REPORT' with several lines of text. Below this is a section titled 'WARNING' with a black background and white text. The rest of the form consists of several sections of horizontal lines for text entry. The image is labeled with 'C' in a white box in the top left corner.

HYDRAULIC EXCAVATOR IDENTIFICATION



CD-13291
CD-13292

MACHINE SIGNS TRANSLATIONS (DECALS)

Follow the instructions on all the Machine Signs (Decals) that are on the excavator. Replace any damaged machine signs and be sure they are in the correct locations. Machine signs are available from your Bobcat Hydraulic Excavator dealer.

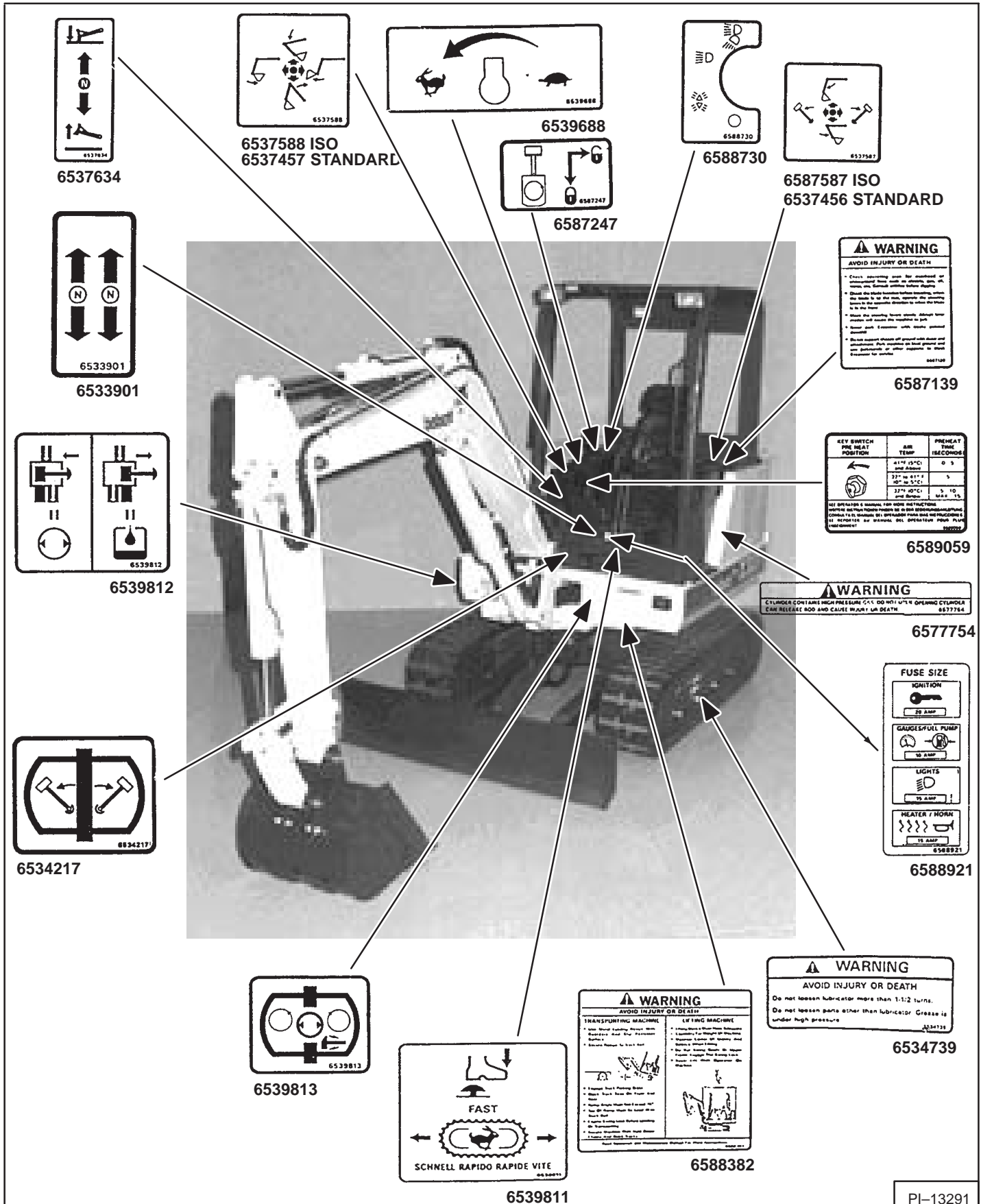

**Thank you very much
for your reading.**

**Please click here and go
back to the website.**

**Then, you can
download the complete
manual instantly.**

No waiting.