

T140



Bobcat®

Service Manual

S/N 527111001 & Above
S/N 527211001 & Above

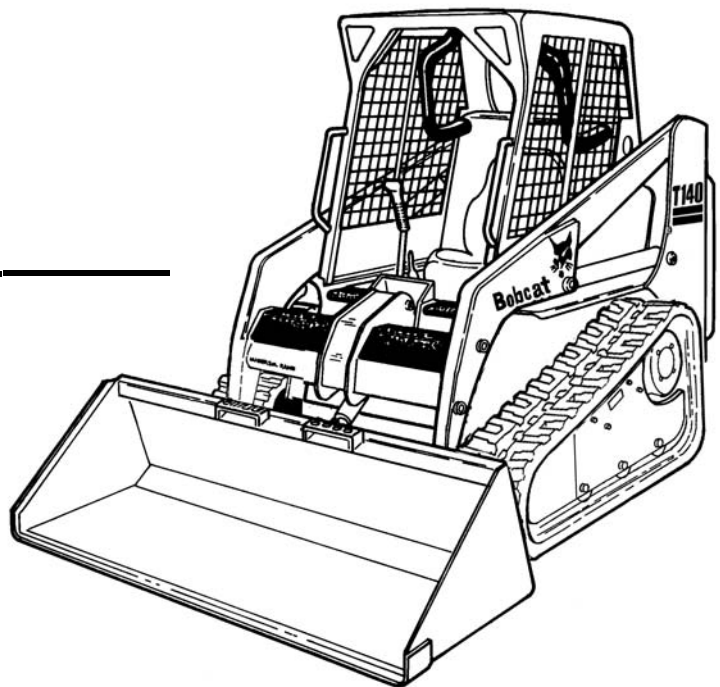

EQUIPPED WITH
BOBCAT INTERLOCK
CONTROL SYSTEM (BICS™)

6903153 (2-06)

 **Ingersoll Rand**
Compact Vehicle Technologies

Printed in U.S.A.

© Bobcat Company 2006

ALPHABETICAL INDEX

ADVANCED CONTROL SYSTEM (ACS)		
SELECTRABLE HAND/FOOT CONTROL.....	60-01	
ALTERNATOR	60-01	
AIR CLEANER SERVICE	10-01, 70-01	
BASIC TROUBLESHOOTING	80-01	
BATTERY	60-01	
BICS™ SYSTEM	60-01	
BOBCAT CONTROLLER	60-01	
BOB-TACH.....	10-01, 50-01	
BRAKE	40-01	
BUCKET POSITION VALVE.....	20-01	
CHARGE PRESSURE	30-01	
COMPONENTS	80-01	
CONTROL HANDLE	50-01	
CONTROL PANEL	50-01	
CONTROL PEDALS	50-01	
CONTROL PEDALS (ACS)	50-01	
CONVERSIONS	SPEC-01	
COOLING FAN	70-01	
CYLINDER (LIFT).....	20-01	
CYLINDER (POWER BOB-TACH).....	20-01	
CYLINDER (TILT)	20-01	
DIAGNOSTICS SERVICE CODES.....	60-01	
DRIVE BELT	30-01	
DRIVE COMPONENTS	40-01	
ELECTRICAL/HYD. CONTROLS REFERENCE	60-01	
ELECTRICAL SYSTEM INFORMATION	60-01	
ENGINE	70-01	
ENGINE COMPONENTS AND TESTING	70-01	
ENGINE COOLING SYSTEM.....	10-01	
ENGINE LUBRICATION SYSTEM	10-01	
ENGINE SPECIFICATIONS.....	SPEC-01	
ENGINE SPEED CONTROL	70-01	
FAN GEARBOX	10-01	
FINAL DRIVE TRANSMISSION (CHAINCASE).....	10-01	
FLYWHEEL AND HOUSING.....	70-01	
FLYWHEEL RPM SENSOR.....	60-01	
FRONT AUXILIARY HYDRAULIC		
COUPLER BLOCK	20-01	
FUEL SYSTEM	10-01	
FUEL TANK.....	50-01	
HEATER UNIT	80-01	
HEATER COIL	80-01	
HEATER FAN	80-01	
HEATER VALVE.....	80-01	
HYDRAULIC CONNECTION SPECS.....	SPEC-01	
HYDRAULIC CONTROL VALVE (ADVANCED		
CONTROL SYSTEM) (ACS).....	20-01	
HYDRAULIC CONTROL VALVE		
(FOOT CONTROL)	20-01	
HYDRAULIC FLUID RESERVOIR	20-01	
HYDRAULIC/HYDROSTATIC FILTER	20-01	
HYDRAULIC FLUID SPECIFICATIONS.....	SPEC-01	
HYDRAULIC/HYDROSTATIC SYSTEM.....	10-01	
HYDRAULIC SYSTEM INFORMATION	20-01	
HYDRAULIC PUMP	20-01	
HYDROSTATIC MOTOR	30-01	
HYDROSTATIC PUMP	30-01	
HYDROSTATIC SYSTEM INFORMATION.....	30-01	
INSTRUMENT PANEL	60-01	
LIFT ARM	50-01	
LIFT ARM BY-PASS CONTROL VALVE.....	20-01	
LIFT ARM SUPPORT DEVICE.....	10-01	
LIFTING AND BLOCKING THE LOADER.....	10-01	
LIGHTS.....	60-01	
LOADER SPECIFICATIONS	SPEC-01	
LUBRICATION OF THE BOBCAT LOADER	10-01	
MAIN RELIEF VALVE	20-01	
MUFFLER.....	70-01	
OIL COOLER.....	30-01	
OPERATOR CAB	10-01, 50-01	
OPERATOR SEAT	50-01	
POWER BOB-TACH.....	10-01, 50-01	
POWER BOB-TACH BLOCK.....	20-01	
RADIATOR.....	70-01	
REAR AUXILIARY DEVERTER	20-01	
REAR DOOR	50-01	
REAR GRILL	50-01	
RECONDITIONING THE ENGINE	70-01	
REGULAR MAINTENANCE	80-01	
REMOTE START	10-01	
SEAT BAR.....	50-01	
SEAT BAR SENSOR.....	60-01	
SERVICE SCHEDULE.....	10-01	
SPARK ARRESTOR MUFFLER.....	10-01	
STARTER	60-01	
SYSTEM TROUBLESHOOTING CHART	80-01	
TORQUE SPECIFICATIONS FOR BOLTS	SPEC-01	
TOWING THE LOADER	10-01	
TRACTION LOCK	60-01	
TRANSPORTING THE LOADER	10-01	
TROUBLESHOOTING	70-01	

MAINTENANCE SAFETY



WARNING

Instructions are necessary before operating or servicing machine. Read and understand the Operation & Maintenance Manual, Operator's Handbook and signs (decals) on machine. Follow warnings and instructions in the manuals when making repairs, adjustments or servicing. Check for correct function after adjustments, repairs or service. Untrained operators and failure to follow instructions can cause injury or death.

W-2003-0903



Safety Alert Symbol: This symbol with a warning statement, means: "Warning, be alert! Your safety is involved!" Carefully read the message that follows.

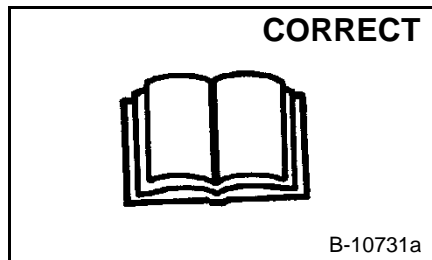

⚠ Never service the Bobcat Compact Track Loader without instructions.

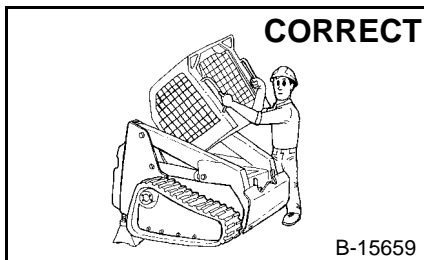

⚠ Use the correct procedure to lift or lower operator cab.

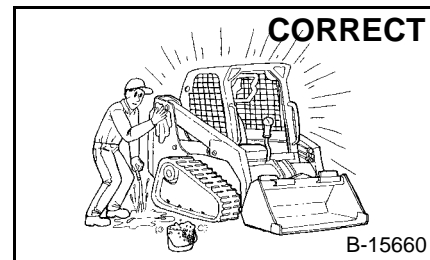

⚠ Cleaning and maintenance are required daily.

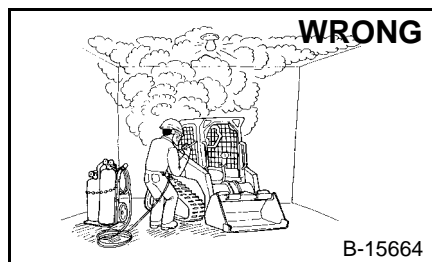

⚠ Have good ventilation when welding or grinding painted parts.
 ⚠ Wear dust mask when grinding painted parts. Toxic dust and gas can be produced.
 ⚠ Avoid exhaust fume leaks which can kill without warning. Exhaust system must be tightly sealed.

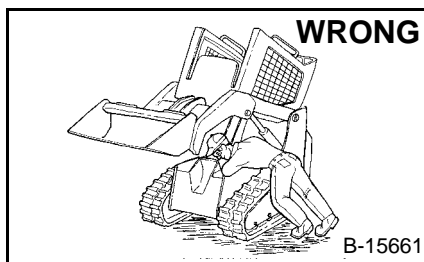

⚠ Disconnecting or loosening any hydraulic tubeline, hose, fitting, component or a part failure can cause lift arms to drop. Do not go under lift arms when raised unless supported by an approved lift arm support device. Replace it if damaged.

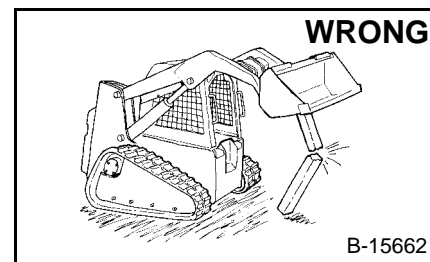

⚠ Never work on loader with lift arms up unless lift arms are held by an approved lift arm support device. Replace if damaged.
 ⚠ Never modify equipment or add attachments not approved by Bobcat Company.

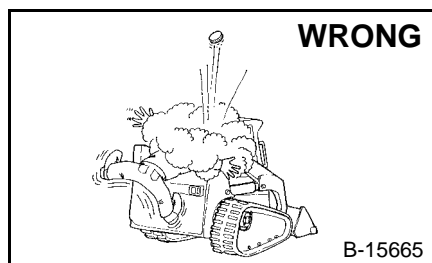

⚠ Stop, cool and clean engine of flammable materials before checking fluids.
 ⚠ Never service or adjust loader with the engine running unless instructed to do so in the manual.
 ⚠ Avoid contact with leaking hydraulic fluid or diesel fuel under pressure. It can penetrate the skin or eyes.
 ⚠ Never fill fuel tank with engine running, while smoking or when near open flame.

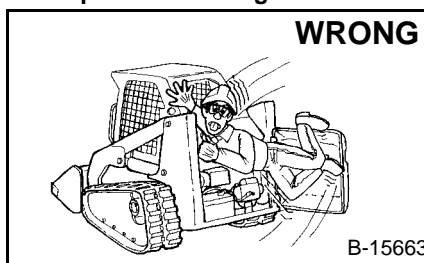

⚠ Keep body, jewelry and clothing away from moving parts, electrical contact, hot parts and exhaust.
 ⚠ Wear eye protection to guard from battery acid, compressed springs, fluids under pressure and flying debris when engines are running or tools are used. Use eye protection approved for type of welding.
 ⚠ Keep rear door closed except for service. Close and latch door before operating the loader.



⚠ Lead-acid batteries produce flammable and explosive gases.
 ⚠ Keep arcs, sparks, flames and lighted tobacco away from batteries.
 ⚠ Batteries contain acid which burns eyes or skin on contact. Wear protective clothing. If acid contacts body, flush well with water. For eye contact flush well and get immediate medical attention.

Maintenance procedures which are given in the Operation & Maintenance Manual can be performed by the owner/operator without any specific technical training. Maintenance procedures which are **not** in the Operation & Maintenance Manual must be performed **ONLY BY QUALIFIED BOBCAT SERVICE PERSONNEL**. Always use **genuine Bobcat replacement parts**. The Service Safety Training Course is available from your Bobcat dealer.

CONTENTS

FOREWORD.....	II
SAFETY INSTRUCTIONS	V
SERIAL NUMBER LOCATIONS	IX
DELIVERY REPORT.....	X
LOADER IDENTIFICATION	XI
SAFETY AND MAINTENANCE.....	10-01
HYDRAULIC SYSTEM	20-01
HYDROSTATIC SYSTEM.....	30-01
DRIVE SYSTEM	40-01
MAIN FRAME	50-01
ELECTRICAL SYSTEM & ANALYSIS.....	60-01
ENGINE SERVICE	70-01
HEATER	80-01
SPECIFICATIONS.....	SPEC-01

**SAFETY &
MAINTENANCE**

**HYDRAULIC
SYSTEM**

**HYDROSTATIC
SYSTEM**

**DRIVE
SYSTEM**

MAIN FRAME

**ELECTRICAL
SYSTEM &
ANALYSIS**

**ENGINE
SERVICE**

HEATER

SPECIFICATIONS

FOREWORD

This manual is for the Bobcat loader mechanic. It provides necessary servicing and adjustment procedures for the Bobcat loader and its component parts and systems. Refer to the Operation & Maintenance Manual for operating instructions, starting procedure, daily checks, etc.

A general inspection of the following items must be made after the loader has had service or repair:

1. Check that the ROPS/FOPS (Including side screens) is in good condition and is not modified.

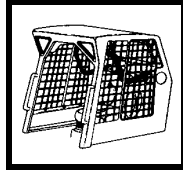

2. Check that ROPS mounting hardware is tightened and is Bobcat approved.



3. The seat belt must be correctly installed, functional and in good condition.

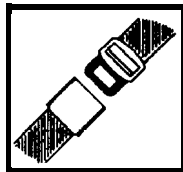

4. The seat bar must be correctly adjusted, clean and lubricated.

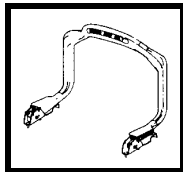

5. Check lift arm support device, replace if damaged.

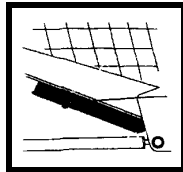

6. Machine signs must be legible and in the correct location.



7. Steering levers and foot pedals must return to neutral.

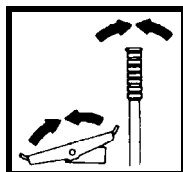

8. Check for correct function of the work lights



9. The parking brake must function correctly.



10. Enclosure door latches must open and close freely.

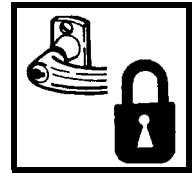

11. Bob-Tach wedges and linkages must function correctly and be in good condition.

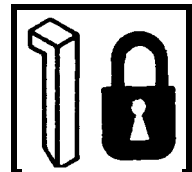

12. Safety treads must be in good condition.

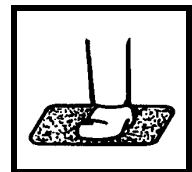

13. Check for correct function of indicator lamps (Optional on some models).

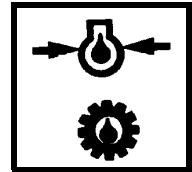

14. Check hydraulic fluid level, engine oil level and fuel supply.

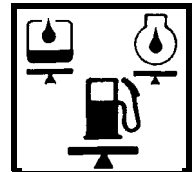

15. Inspect for fuel, oil or hydraulic fluid leaks.

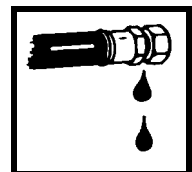

16. Lubricate the loader.

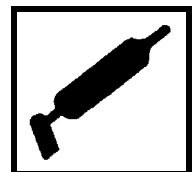

17. Check the condition of the battery and cables.

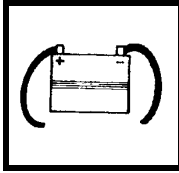

22. Operate the loader and check all functions.

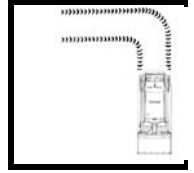

18. Inspect the air cleaner for damage or leaks. Check the condition of the element.

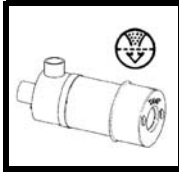

23. Check for any field modification not completed.



19. Check the electrical charging system.

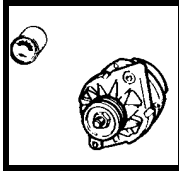

24. Check for correct function of the Bobcat Interlock Control System (BICST™) before the machine is returned to the customer.

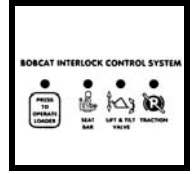

20. Check tracks for wear and tension.

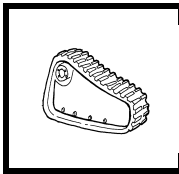

Recommend to the owner that all necessary corrections be made before the machine is returned to service.

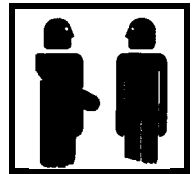

21. Inspect for loose or broken parts or connections.

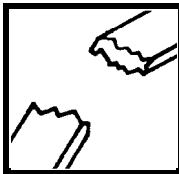

**CALIFORNIA
PROPOSITION 65 WARNING**

Diesel engine exhaust and some of its constituents are known to the State of California to cause cancer, birth defects and other reproductive harm.

SAFETY INSTRUCTIONS



Safety Alert Symbol

This symbol with a warning statement means: "Warning, be alert! Your safety is involved!" Carefully read the message that follows.



WARNING

Instructions are necessary before operating or servicing machine. Read and understand the Operation & Maintenance Manual, Operator's Handbook and signs (decals) on machine. Follow warnings and instructions in the manuals when making repairs, adjustments or servicing. Check for correct function after adjustments, repairs or service. Untrained operators and failure to follow instructions can cause injury or death.

W-2003-0903



WARNING

Warnings on the machine and in the manuals are for your safety. Failure to obey warnings can cause injury or death.

W-2044-1285

IMPORTANT

This notice identifies procedures which must be followed to avoid damage to the machine.

I-2019-0284

The following publications provide information on the safe use and maintenance of the Bobcat machine and attachments:

- The Delivery Report is used to assure that complete instructions have been given to the new owner and that the machine is in safe operating condition.
- The Operation & Maintenance Manual delivered with the machine or attachment contains operating information as well as routine maintenance and service procedures. It is a part of the machine and can be stored in a container provided on the machine. Replacement Operation & Maintenance Manuals can be ordered from your Bobcat dealer.
- Machine signs (decals) instruct on the safe operation and care of your Bobcat machine or attachment. The signs and their locations are shown in the Operation & Maintenance Manual. Replacement signs are available from your Bobcat dealer.
- An Operator's Handbook fastened to the operator cab. It's brief instructions are convenient to the operator. The handbook is available from your dealer in an English edition or one of many other languages. See your Bobcat dealer for more information on translated versions.
- The AEM Safety Manual delivered with the machine gives general safety information.
- The Service Manual and Parts Manual are available from your dealer for use by mechanics to do shop-type service and repair work.
- The Skid-Steer Loader Operator Training Course is available through your local dealer or at www.training.bobcat.com or www.bobcat.com. This course is intended to provide rules and practices of correct operation of the Skid-Steer Loader. The course is available in English and Spanish versions.
- Service Safety Training Courses are available from your Bobcat dealer or at www.training.bobcat.com or www.bobcat.com. They provide information for safe and correct service procedures.
- The Skid-Steer Loader Safety Video is available from your Bobcat dealer or at www.training.bobcat.com or www.bobcat.com.

SI SSL-0206 SM

SAFETY INSTRUCTIONS (CONT'D)

Fire Prevention

The machine and attachments have components that are at high temperature under normal operating conditions. The primary source of high temperatures is the engine and exhaust system. The electrical system, if damaged or incorrectly maintained, can be a source of arcs or sparks.

Flammable debris (leaves, straw, etc.) must be removed regularly. If flammable debris is allowed to accumulate, it will increase fire hazard. Clean often to avoid this accumulation. Flammable debris in the engine compartment is a potential hazard.

The spark arrestor muffler is designed to control the emission of hot particles from the engine and exhaust system, but the muffler and the exhaust gases are still hot.

- Do not use the machine where exhaust, arcs, sparks or hot components can contact flammable material, explosive dust or gases.
- The operator cab, engine compartment, and engine cooling system must be inspected every day and cleaned if necessary to prevent fire hazard and overheating.
- Check all electrical wiring and connections for damage. Keep the battery terminals clean and tight. Repair or replace any damaged part.
- Check fuel and hydraulic tubes, hoses and fittings for damage and leakage. Never use open flame or bare skin to check for leaks. Tighten or replace any parts that show leakage. Always clean fluid spills. Do not use gasoline or diesel fuel for cleaning parts. Use commercial nonflammable solvents.
- Do not use ether or starting fluids on any engine which has glow plugs. These starting aids can cause explosion and injure you or bystanders.
- Always clean the machine, disconnect the battery, and disconnect the wiring from the controllers before welding. Cover rubber hoses, battery and all other flammable parts. Keep a fire extinguisher near the machine when welding. Have good ventilation when grinding or welding painted parts. Wear a dust mask when grinding painted parts. Toxic dust or gas can be produced.
- Stop the engine and let it cool before adding fuel. **NO SMOKING!**

- Use the procedure in the Operation & Maintenance Manual for connecting the battery and for jump starting.
- Use the procedure in the Operation & Maintenance Manual for cleaning the spark arrestor muffler (if equipped).

Figure 1

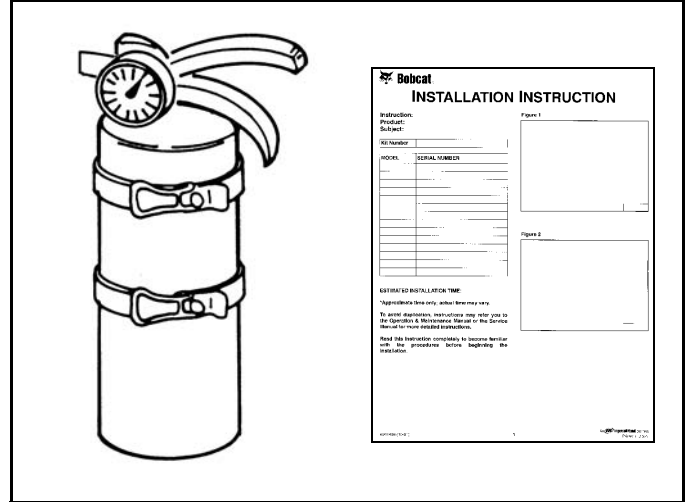

- Know where fire extinguishers and first aid kits are located and how to use them. Fire extinguishers are available from your Bobcat dealer [Figure 1].

SERIAL NUMBER LOCATIONS

Always use the serial number of the loader when requesting service information or when ordering parts. Early or later models (identification made by serial number) may use different parts, or it may be necessary to use a different procedure in doing a specific service operation.

Loader Serial Number

Figure 2

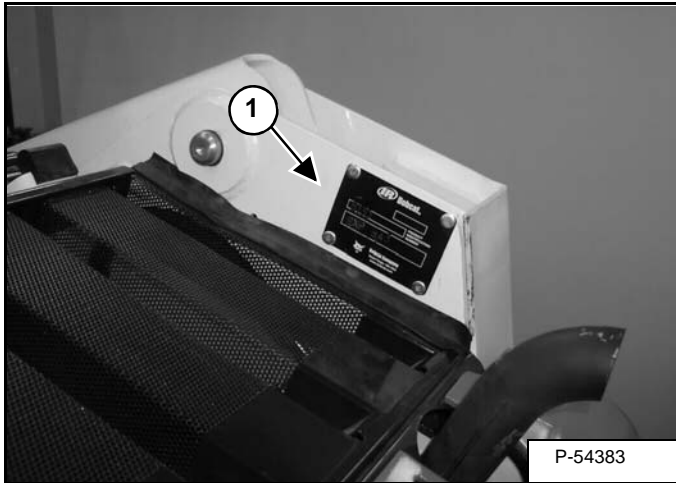

The loader serial number plate is located on the outside of the loader frame [Figure 2].

Explanation of loader Serial Number:

XXXX	XXXXX
Model 1.-Model/ Engine Combination	Model 2.-Production Sequence (Series)

1. The four digit Model/Engine Combination Module number identifies the model number and engine combination.
2. The five digit Production Sequence Number identifies the order which the loader is produced.

Engine Serial Number

Figure 3

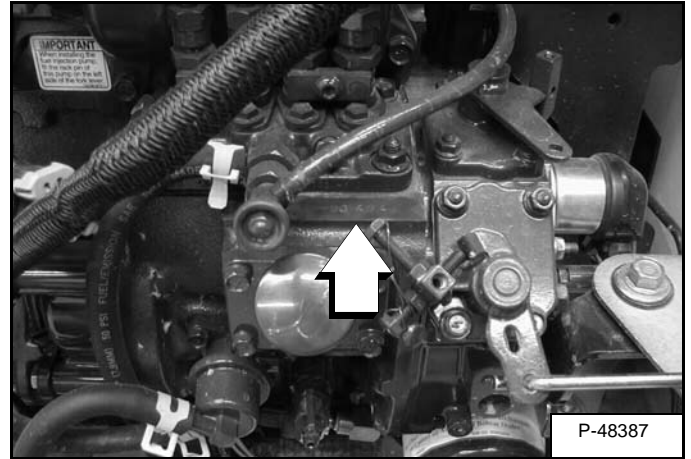

The engine serial number is in the location shown [Figure 3].

DELIVERY REPORT

Figure 4

DELIVERY REPORT

WARNING

B-16315

The Delivery Report must be filled out by the dealer and signed by the owner or operator when the Bobcat loader is delivered. An explanation of the form must be given to the owner. Make sure it is filled out completely **[Figure 4]**.

LOADER IDENTIFICATION

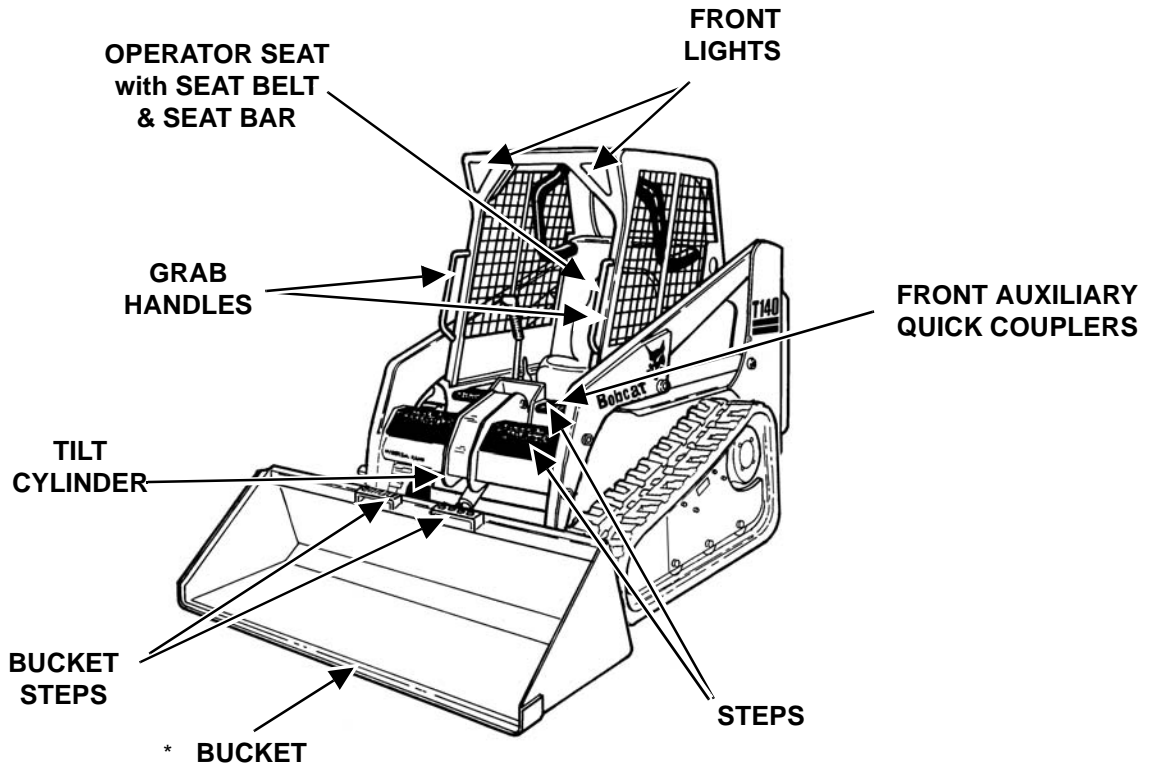

B-22239

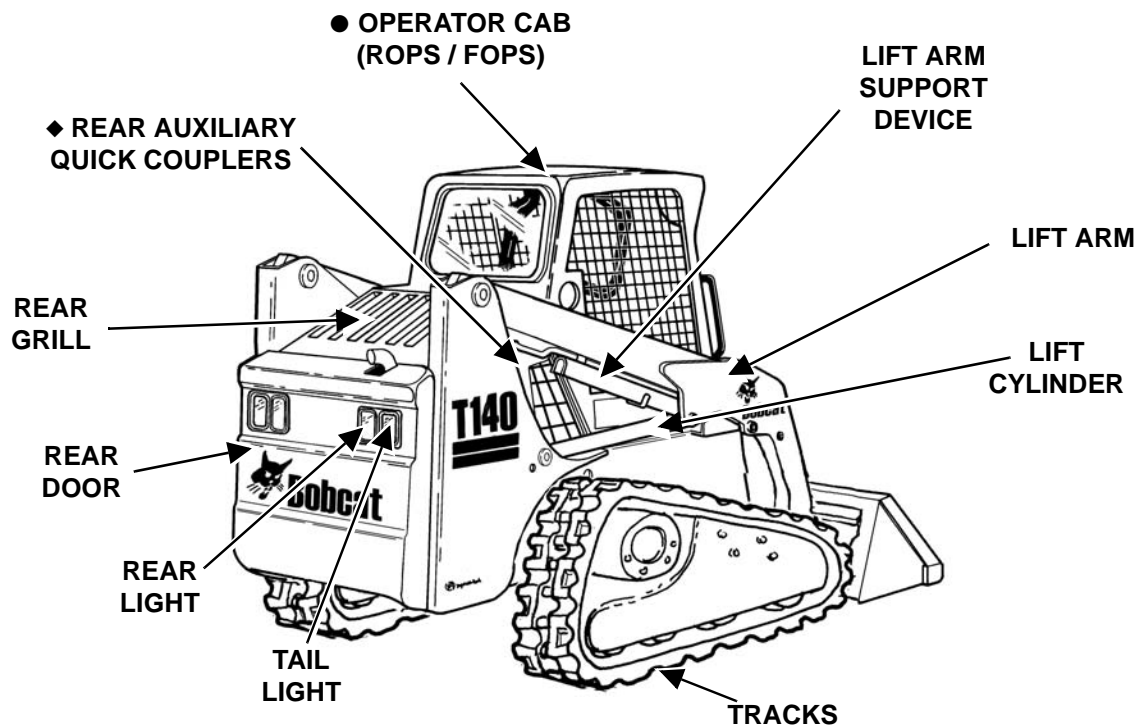

B-24240

◆ Optional or Field Accessory (Not Standard Equipment)

* Bucket - Several different buckets and other attachments are available for this machine.

● ROPS, FOPS - Roll Over Protective Structure, per SAE / ISO 3471, and Falling Object Protective Structure per ISO 3449, Level I. Level II is available.

SAFETY AND MAINTENANCE

SAFETY AND MAINTENANCE

AIR CLEANER SERVICE	10-80-1
Checking	10-80-1
Replacing Filter Element(s)	10-80-2
BOB-TACH™	10-140-1
Inspection And Maintenance	10-140-1
ENGINE COOLING SYSTEM	10-90-1
Cleaning The Cooling System	10-90-1
Checking The Coolant Level	10-90-2
Replacing The Coolant	10-90-3
ENGINE LUBRICATION SYSTEM	10-110-1
Checking Engine Oil	10-110-1
Oil Chart	10-110-1
Replacing Oil And Filter	10-110-1
FAN GEARBOX	10-130-1
Checking And Maintaining	10-130-1
FUEL SYSTEM	10-100-1
Filling The Fuel Tank	10-100-1
Fuel Filter	10-100-2
Fuel Specifications	10-100-1
Removing Air From The Fuel System	10-100-2
HYDRAULIC/HYDROSTATIC SYSTEM	10-120-1
Breather Cap	10-120-4
Checking And Adding Fluid	10-120-1
Replacing Hydraulic Fluid	10-120-3
Replacing Hydraulic/Hydrostatic Filter	10-120-1
Replacing Hydrostatic Motor Case Drain Filter(s)	10-120-2
LIFT ARM SUPPORT DEVICE	10-20-1
Installing Lift Arm Support Device	10-20-1
Removing The Lift Arm Support Device	10-20-2
LIFTING AND BLOCKING THE LOADER	10-10-1
Procedure	10-10-1

Continued On Next Page

SAFETY AND MAINTENANCE (CONT'D)

LUBRICATION OF THE BOBCAT LOADER.....	10-150-1
Procedure	10-150-1
OPERATOR CAB	10-30-1
Description	10-30-1
Emergency Exit	10-30-3
Lowering The Operator Cab	10-30-2
Raising The Operator Cab.....	10-30-1
POWER BOB-TACH™	10-141-1
Inspection And Maintenance	10-141-1
REMOTE START.....	10-60-1
Procedure	10-60-1
SERVICE SCHEDULE	10-70-1
Chart	10-70-1
SPARK ARRESTOR MUFFLER	10-160-1
Servicing	10-160-1
TOWING THE LOADER	10-50-1
Procedure	10-50-1
TRANSPORTING THE BOBCAT LOADER	10-40-1
Procedure	10-40-1

TIGHTEN ALL HARDWARE PER SIZE TO GRADE 5 TORQUE (SEE STANDARD TORQUE SPECIFICATIONS FOR BOLTS, SECTION SPEC-01) UNLESS OTHERWISE SPECIFIED.

LIFTING AND BLOCKING THE LOADER

Procedure

Figure 10-10-1

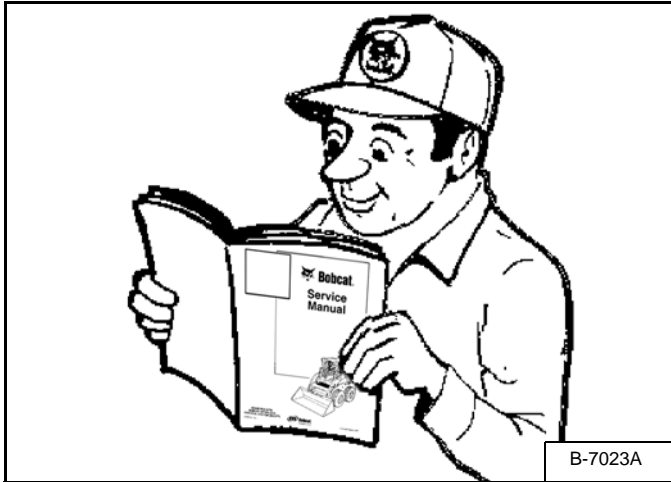

WARNING

Instructions are necessary before operating or servicing machine. Read and understand the Operation & Maintenance Manual, Handbook and signs (decals) on machine. Follow warnings and instructions in the manuals when making repairs, adjustments or servicing. Check for correct function after adjustments, repairs or service. Untrained operators and failure to follow instructions can cause injury or death.

W-2003-0199

Always park the loader on a level surface.

WARNING

Put jack stands under the front axles and rear corners of the frame before running the engine for service. Failure to use jack stands can allow the machine to fall or move and cause injury or death.

W-2017-0286

Figure 10-10-2



Put floor jack under the rear of the loader.

Lift the rear of the loader and install jack stands [Figure 10-10-2].

Figure 10-10-3

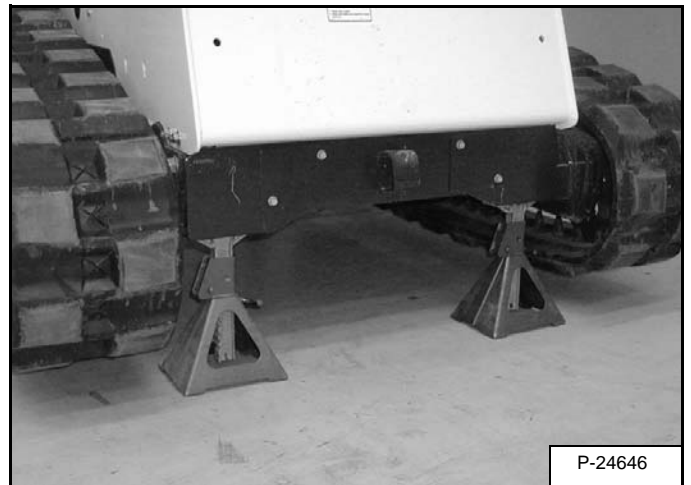

Put the floor jack under the front of the loader [Figure 10-10-3].

Lift the front of the loader and put jack stands under the axle tubes [Figure 10-10-3].

NOTE: Make sure the jack stands do not touch the tires. Make sure tires clear floor or any obstacles.

LIFT ARM SUPPORT DEVICE

Installing Lift Arm Support Device

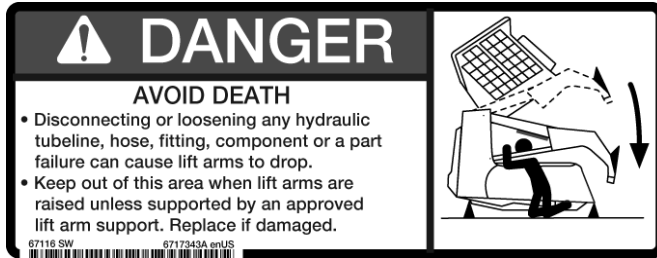

Never work on a machine with the lift arms up unless the lift arms are secured by an approved lift arm support device. Failure to use an approved lift arm support device can allow the lift arms or attachment to fall and cause injury or death.

W-2059-0598



Service lift arm support device if damaged or if parts are missing. Using a damaged lift arm support or with missing parts can cause lift arms to drop causing injury or death.

W-2271-1197

Figure 10-20-1

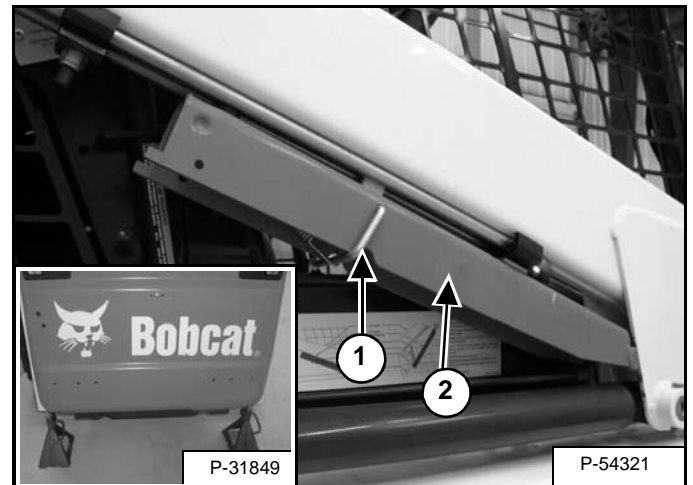

Put jack stands under the rear corners of the loader frame (Inset) [Figure 10-20-1].

Disconnect the spring from the lift arm support device retaining pin (Item 1). Support the lift arm support device (Item 2) [Figure 10-20-1] with your hand and remove the retaining pin.

Figure 10-20-2

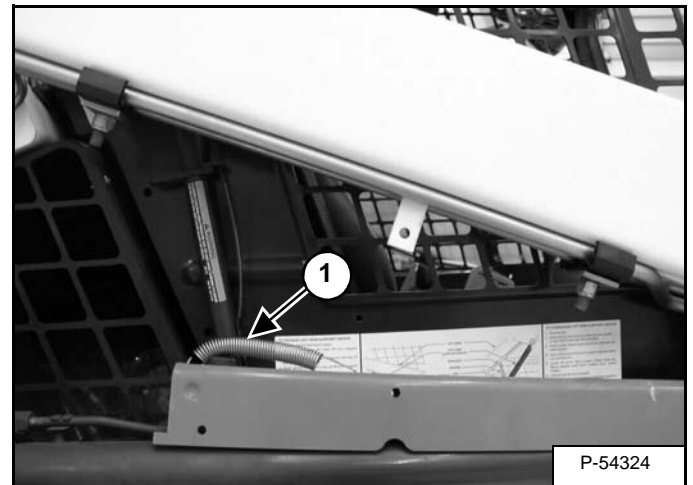

Lower the lift arm support device on top of the lift cylinder. Hook the free end of the spring (Item 1) [Figure 10-20-2] to the lift arm support device so there will be no interference with the support device engagement.

With the operator in the seat, seat belt fastened and seat bar lowered, start the engine.

LIFT ARM SUPPORT DEVICE (CONT'D)

Installing Lift Arm Support Device (Cont'd)

Figure 10-20-3

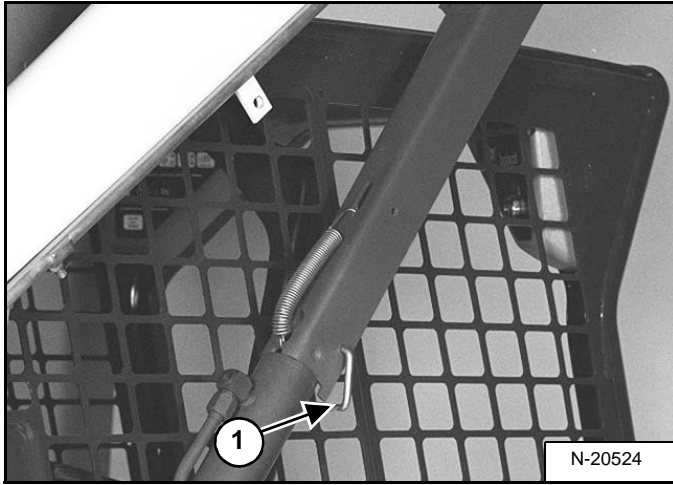

Raise the lift arms, until the lift arm support device drops onto the lift cylinder rod [Figure 10-20-3].

Lower the lift arms slowly until the support device is held between the lift arm and the lift cylinder. Stop the engine. Raise the seat bar and move pedals until both pedals lock.

Install pin (Item 1) [Figure 10-20-3] into the rear of the lift arm support device below the cylinder rod.

Removing The Lift Arm Support Device

Figure 10-20-4

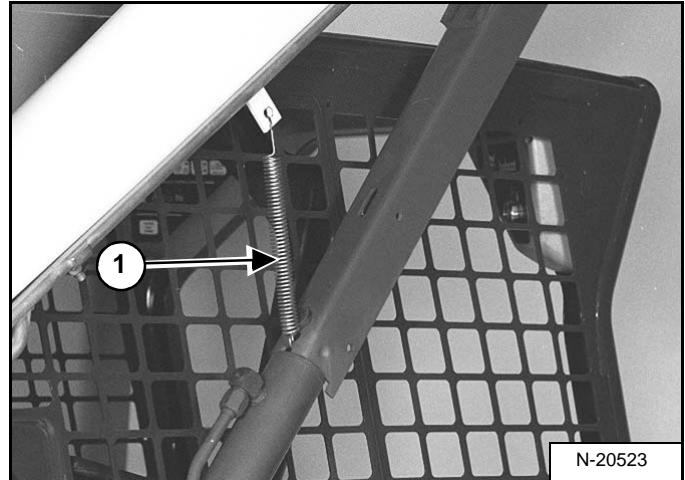

Remove the pin from the lift arm support device.

Connect the spring (Item 1) [Figure 10-20-4] from the lift arm support device to the bracket below the lift arms.

With the operator in the seat, seat belt fastened and seat bar lowered, start the engine.

Raise the lift arms a small amount and the spring will lift the support device off the lift cylinder rod. Lower the lift arms. Stop the engine.

Raise the seat bar and move pedals until all pedals lock.

Disconnect the spring from the bracket.

Figure 10-20-5

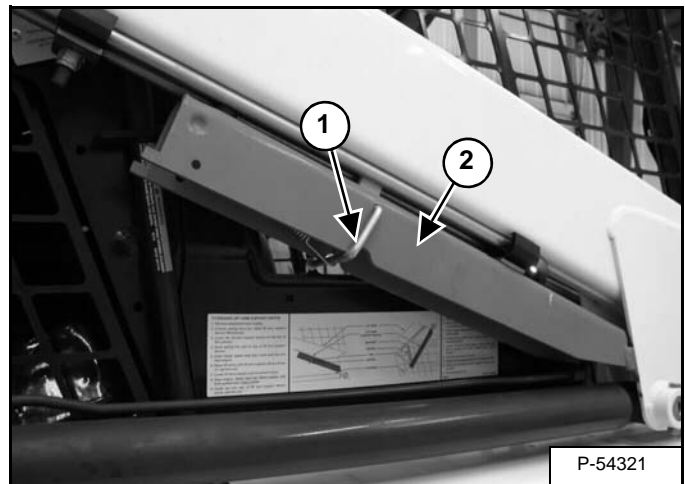

Raise the support device into storage position and insert pin (Item 1) through lift arm support device (Item 2) [Figure 10-20-5] and bracket. Connect spring to pin.

Remove jack stands.

**Thank you very much
for your reading.**

**Please click here and go
back to the website.**

**Then, you can
download the complete
manual instantly.**

No waiting.