

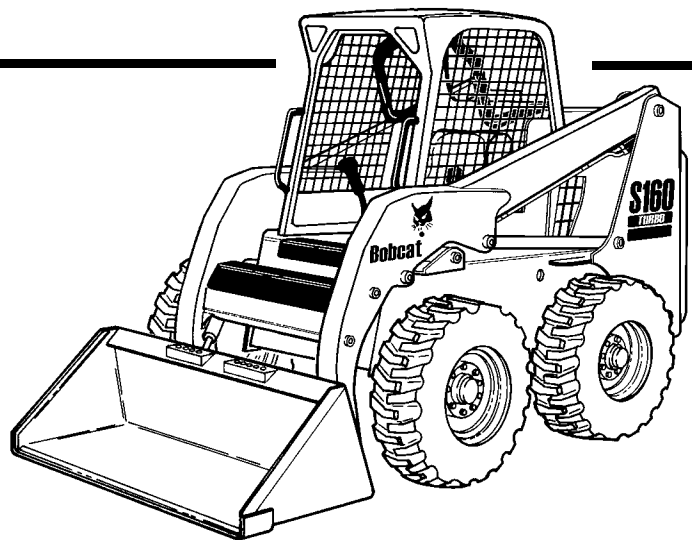

**Bobcat®**

# Service Manual

S/N 523811001 & Above  
S/N 523911001 & Above  
S/N 524011001 & Above  
S/N 524111001 & Above



EQUIPPED WITH  
BOBCAT INTERLOCK  
CONTROL SYSTEM (BICS™)  
6902498 (3-06)



Printed in U.S.A.

©Bobcat Company 2006

# MAINTENANCE SAFETY



## WARNING

Instructions are necessary before operating or servicing machine. Read and understand the Operation & Maintenance Manual, Operator's Handbook and signs (decals) on machine. Follow warnings and instructions in the manuals when making repairs, adjustments or servicing. Check for correct function after adjustments, repairs or service. Untrained operators and failure to follow instructions can cause injury or death.

W-2003-0903



**Safety Alert Symbol:** This symbol with a warning statement, means: "Warning, be alert! Your safety is involved!" Carefully read the message that follows.

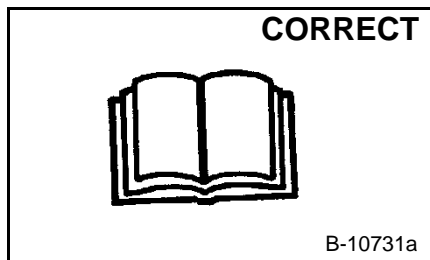

Never service the Bobcat Skid-Steer Loader without instructions.

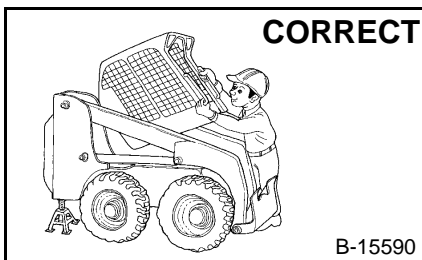

Use the correct procedure to lift or lower operator cab.

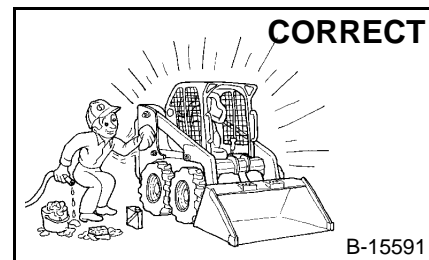

Cleaning and maintenance are required daily.

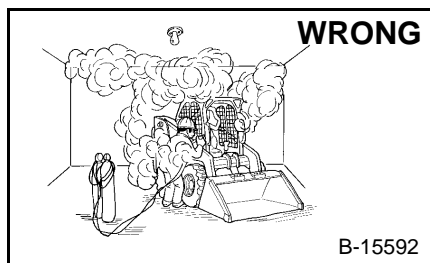

Have good ventilation when welding or grinding painted parts.

Wear dust mask when grinding painted parts. Toxic dust and gas can be produced.

Avoid exhaust fume leaks which can kill without warning. Exhaust system must be tightly sealed.

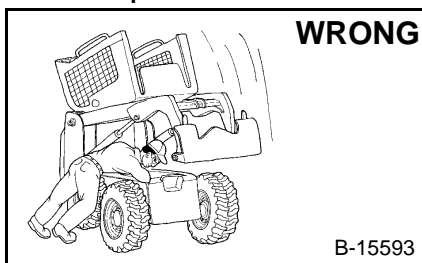

Disconnecting or loosening any hydraulic tubeline, hose, fitting, component or a part failure can cause lift arms to drop. Do not go under lift arms when raised unless supported by an approved lift arm support device. Replace it if damaged.

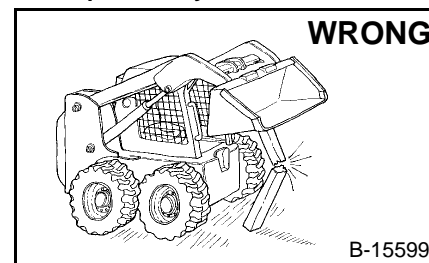

Never work on loader with lift arms up unless lift arms are held by an approved lift arm support device. Replace if damaged.

Never modify equipment or add attachments not approved by Bobcat Company.

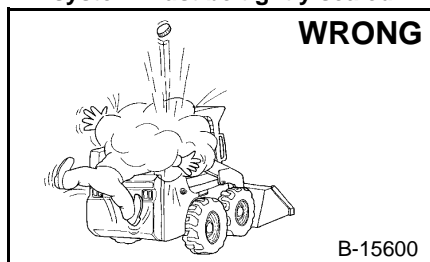

Stop, cool and clean engine of flammable materials before checking fluids.

Never service or adjust loader with the engine running unless instructed to do so in the manual.

Avoid contact with leaking hydraulic fluid or diesel fuel under pressure. It can penetrate the skin or eyes.

Never fill fuel tank with engine running, while smoking or when near open flame.

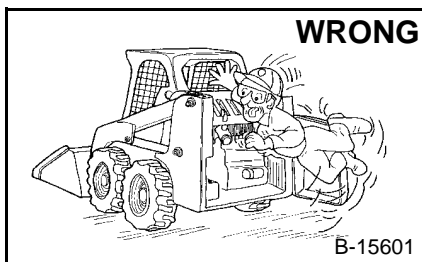

Keep body, jewelry and clothing away from moving parts, electrical contact, hot parts and exhaust.

Wear eye protection to guard from battery acid, compressed springs, fluids under pressure and flying debris when engines are running or tools are used. Use eye protection approved for type of welding.

Keep rear door closed except for service. Close and latch door before operating the loader.

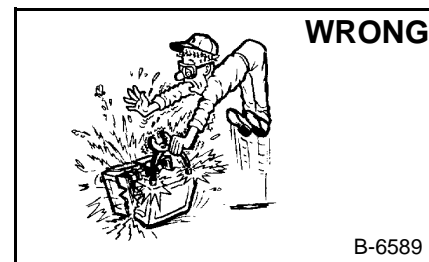

Lead-acid batteries produce flammable and explosive gases.

Keep arcs, sparks, flames and lighted tobacco away from batteries.

Batteries contain acid which burns eyes or skin on contact. Wear protective clothing. If acid contacts body, flush well with water. For eye contact flush well and get immediate medical attention.

Maintenance procedures which are given in the Operation & Maintenance Manual can be performed by the owner/operator without any specific technical training. Maintenance procedures which are **not** in the Operation & Maintenance Manual must be performed **ONLY BY QUALIFIED BOBCAT SERVICE PERSONNEL**. Always use genuine Bobcat replacement parts. The Service Safety Training Course is available from your Bobcat dealer.

MSW08-0805

## ALPHABETICAL INDEX

ADVANCED CONTROL SYSTEM (ACS) .....	60-01	HEATER COIL .....	80-01
AIR CLEANER .....	70-01	HEATER/AC FAN .....	80-01
AIR CLEANER SERVICE .....	10-01	HEATER VALVE .....	80-01
AIR CONDITIONING SERVICE .....	80-01	HIGH FLOW VALVE .....	20-01
AIR CONDITIONING SYSTEM FLOW .....	80-01	HYDRAULIC CONNECTION SPECS. ....	SPEC-01
ALTERNATOR .....	60-01	HYDRAULIC CONTROL VALVE (ADVANCED CONTROL SYSTEM) (ACS) .....	20-01
BATTERY .....	60-01	HYDRAULIC CONTROL VALVE (FOOT CONTROL).....	20-01
BASIC TROUBLESHOOTING .....	80-01	HYDRAULIC FILTER HOUSING .....	20-01
BICS™ SYSTEM .....	60-01	HYDRAULIC FLUID RESERVOIR .....	20-01
BOBCAT CONTROLLER .....	60-01	HYDRAULIC FLUID SPECIFICATIONS .....	SPEC-01
BOB-TACH .....	10-01, 50-01	HYDRAULIC/HYDROSTATIC SYSTEM.....	10-01
BRAKE .....	40-01	HYDRAULIC PUMP .....	20-01
BUCKET POSITION VALVE .....	20-01	HYDRAULIC PUMP (HI FLOW) .....	20-01
CHAINCASE .....	40-01	HYDRAULIC SYSTEM INFORMATION .....	20-01
CHARGE PRESSURE .....	30-01	HYDROSTATIC MOTOR .....	30-01
COMPONENTS .....	80-01	HYDROSTATIC PUMP .....	30-01
COMPRESSOR .....	80-01	HYDROSTATIC SYSTEM INFORMATION .....	30-01
CONDENSER .....	80-01	INSTRUMENT PANEL.....	60-01
CONTROL HANDLE .....	50-01	LIFT ARMS .....	50-01
CONTROL HANDLE (ADVANCED CONTROL SYSTEM) (ACS) SELECTABLE HAND/FOOT CONTROL....	50-01	LIFT ARM BY-PASS CONTROL VALVE .....	20-01
CONTROL PANEL .....	50-01	LIFT ARM SUPPORT DEVICE .....	10-01
CONTROL PEDALS .....	50-01	LIFTING AND BLOCKING THE LOADER.....	10-01
CONTROL PEDALS (ACS) .....	50-01	LIGHTS .....	60-01
CONVERSIONS .....	SPEC-01	LOADER SPECIFICATIONS .....	SPEC-01
COOLING FAN .....	70-01	LUBRICATING THE BOBCAT LOADER .....	10-01
CYLINDER (LIFT) .....	20-01	MAIN RELIEF VALVE .....	20-01
CYLINDER (POWER BOB-TACH).....	20-01	MUFFLER.....	70-01
CYLINDER (TILT) .....	20-01	OIL COOLER.....	30-01
DIAGNOSTICS .....	60-01	OPERATOR CAB .....	10-01, 50-01
DRIVE BELT .....	30-01	OPERATOR SEAT .....	50-01
DRIVE COMPONENTS .....	40-01	OPERATOR SEAT (SUSPENSION).....	50-01
ELECTRICAL SYSTEM INFORMATION .....	60-01	POWER BOB-TACH .....	10-01, 50-01
ENGINE .....	70-01	POWER BOB-TACH BLOCK.....	20-01
ENGINE COMPONENTS AND TESTING .....	70-01	PRESSURE RELIEF VALVE .....	80-01
ENGINE COOLING SYSTEM .....	10-01	PRESSURE SWITCH.....	80-01
ENGINE LUBRICATION SYSTEM.....	10-01		
ENGINE SPECIFICATIONS .....	SPEC-01		
ENGINE SPEED CONTROL .....	70-01		
EVAPORATOR.....	80-01		
EVAPORATOR/HEATER UNIT .....	80-01		
EXPANSION VALVE .....	80-01		
FAN GEARBOX .....	10-01		
FINAL DRIVE TRANSMISSION (CHAINCASE) ..	10-01		
FLYWHEEL AND HOUSING .....	70-01		
FRONT AUXILIARY HYD. COUPLER BLOCK.....	20-01		
FUEL SYSTEM .....	10-01		
FUEL TANK.....	50-01		
GENERAL AIR CONDITIOING SERVICE GUIDELINES.....	80-01		

## ALPHABETICAL INDEX (CONT'D)

RPM SENSOR.....	70-01
RADIATOR.....	70-01
REAR AUXILIARY DIVERTER VALVE .....	20-01
REAR DOOR .....	50-01
REAR GRILL .....	50-01
RECEIVER/DRIER .....	80-01
RECONDITIONING THE ENGINE .....	70-01
REGULAR MAINTENANCW .....	80-01
REMOTE START .....	10-01
RPM SENSOR.....	70-01
SAFETY .....	80-01
SEAT BAR .....	50-01
SEAT BAR SENSOR .....	60-01
SERVICE SCHEDULE .....	10-01
SPARK ARRESTOR MUFFLER .....	10-01
STARTER .....	60-01
SYSTEM CHARGING AND RECLAMATION .....	80-01
SYSTEM TROUBLESHOOTING CHART .....	80-01
TEMPERATURE/PRESSURE .....	80-01
THERMOSTAT.....	80-01
TIRE MAINTENANCE .....	10-01
TORQUE SPECIFICATIONS FOR BOLTS ....	SPEC-01
TOWING THE LOADER .....	10-01
TRACTION LOCK.....	60-01
TRANSPORTING THE BOBCAT LOADER.....	10-01
TROUBLESHOOTING.....	70-01
TURBOCHARGER .....	70-01

## CONTENTS

**SAFETY &  
MAINTENANCE**

**HYDRAULIC  
SYSTEM**

**HYDROSTATIC  
SYSTEM**

**DRIVE  
SYSTEM**

**MAIN FRAME**

**ELECTRICAL  
SYSTEM**

**ENGINE  
SERVICE**

**HVAC**

**SPECIFICATIONS**

FOREWORD.....	II
SAFETY INSTRUCTIONS .....	V
SERIAL NUMBER LOCATIONS .....	IX
DELIVERY REPORT.....	X
BOBCAT LOADER IDENTIFICATION.....	XI
SAFETY AND MAINTENANCE.....	10-01
HYDRAULIC SYSTEM .....	20-01
HYDROSTATIC SYSTEM.....	30-01
DRIVE SYSTEM .....	40-01
MAIN FRAME .....	50-01
ELECTRICAL SYSTEM .....	60-01
ENGINE SERVICE .....	70-01
HEATING, VENTILATION, AIR CONDITIONING .....	80-01
SPECIFICATIONS.....	SPEC-01

# FOREWORD

This manual is for the Bobcat loader mechanic. It provides necessary servicing and adjustment procedures for the Bobcat loader and its component parts and systems. Refer to the Operation & Maintenance Manual for operating instructions, Starting procedure, daily checks, etc.

A general inspection of the following items must be made after the loader has had service or repair:

1. Check that the ROPS/FOPS (Including side screens) is in good condition and is not modified.

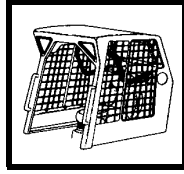

2. Check that ROPS mounting hardware is tightened and is Bobcat approved.

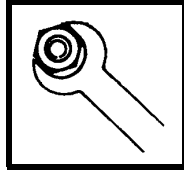

3. The seat belt must be correctly installed, functional and in good condition.

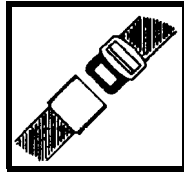

4. The seat bar must be correctly adjusted, clean and lubricated.

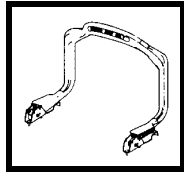

5. Check lift arm support device, replace if damaged.

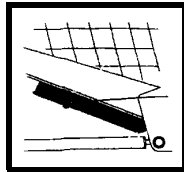

6. Machine signs must be legible and in the correct location.



7. Steering levers and foot pedals must return to neutral.

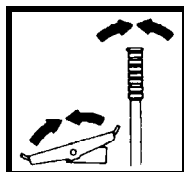

8. Check for correct function of the work lights



9. The parking brake must function correctly.



10. Enclosure door latches must open and close freely.

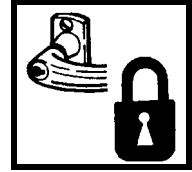

11. Bob-Tach wedges and linkages must function correctly and be in good condition.

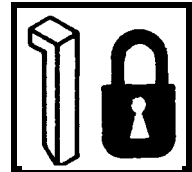

12. Safety treads must be in good condition.

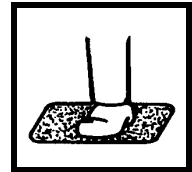

13. Check for correct function of indicator lamps (Optional on some models).

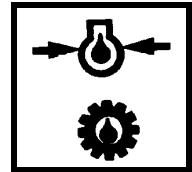

14. Check hydraulic fluid level, engine oil level and fuel supply.

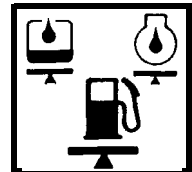

15. Inspect for fuel, oil or hydraulic fluid leaks.

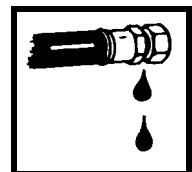

16. Lubricate the loader.

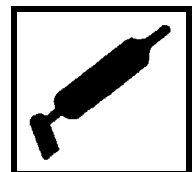

17. Check the condition of the battery and cables.

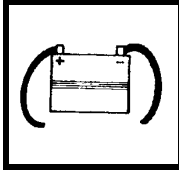

18. Inspect the air cleaner for damage or leaks. Check the condition of the element.

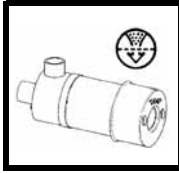

19. Check the electrical charging system.

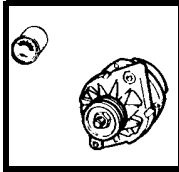

20. Check tires for wear and pressure.

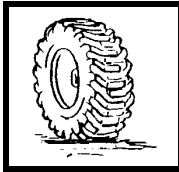

21. Inspect for loose or broken parts or connections.

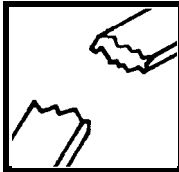

22. Operate the loader and check all functions.

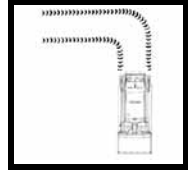

23. Check for any field modification not completed.



24. Check for correct function of the Bobcat Interlock Control System (BICS™) before the machine is returned to the customer.

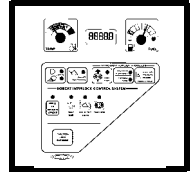

25. Recommend to the owner that all necessary corrections be made before the machine is returned to service.

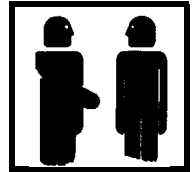

**CALIFORNIA  
PROPOSITION 65 WARNING**  
Diesel engine exhaust and some of its constituents are known to the State of California to cause cancer, birth defects and other reproductive harm.

## SAFETY INSTRUCTIONS



### Safety Alert Symbol

This symbol with a warning statement means:  
“Warning, be alert! Your safety is involved!”  
Carefully read the message that follows.



## WARNING

Instructions are necessary before operating or servicing machine. Read and understand the Operation & Maintenance Manual, Operator's Handbook and signs (decals) on machine. Follow warnings and instructions in the manuals when making repairs, adjustments or servicing. Check for correct function after adjustments, repairs or service. Untrained operators and failure to follow instructions can cause injury or death.

W-2003-0903



## WARNING

Warnings on the machine and in the manuals are for your safety. Failure to obey warnings can cause injury or death.

W-2044-1285

## IMPORTANT

This notice identifies procedures which must be followed to avoid damage to the machine.

I-2019-0284

The following publications provide information on the safe use and maintenance of the Bobcat machine and attachments:

- The Delivery Report is used to assure that complete instructions have been given to the new owner and that the machine is in safe operating condition.
- The Operation & Maintenance Manual delivered with the machine or attachment contains operating information as well as routine maintenance and service procedures. It is a part of the machine and can be stored in a container provided on the machine. Replacement Operation & Maintenance Manuals can be ordered from your Bobcat dealer.
- Machine signs (decals) instruct on the safe operation and care of your Bobcat machine or attachment. The signs and their locations are shown in the Operation & Maintenance Manual. Replacement signs are available from your Bobcat dealer.
- An Operator's Handbook fastened to the operator cab. It's brief instructions are convenient to the operator. The handbook is available from your dealer in an English edition or one of many other languages. See your Bobcat dealer for more information on translated versions.
- The AEM Safety Manual delivered with the machine gives general safety information.
- The Service Manual and Parts Manual are available from your dealer for use by mechanics to do shop-type service and repair work.
- The Skid-Steer Loader Operator Training Course is available through your local dealer or at [www.training.bobcat.com](http://www.training.bobcat.com) or [www.bobcat.com](http://www.bobcat.com). This course is intended to provide rules and practices of correct operation of the Skid-Steer Loader. The course is available in English and Spanish versions.
- Service Safety Training Courses are available from your Bobcat dealer or at [www.training.bobcat.com](http://www.training.bobcat.com) or [www.bobcat.com](http://www.bobcat.com). They provide information for safe and correct service procedures.
- The Skid-Steer Loader Safety Video is available from your Bobcat dealer or at [www.training.bobcat.com](http://www.training.bobcat.com) or [www.bobcat.com](http://www.bobcat.com).

SI SSL-0206 SM

**S150, S160 Bobcat Loader  
Service Manual**



## SAFETY INSTRUCTIONS (CONT'D)

### Fire Prevention

The machine and attachments have components that are at high temperature under normal operating conditions. The primary source of high temperatures is the engine and exhaust system. The electrical system, if damaged or incorrectly maintained, can be a source of arcs or sparks.

Flammable debris (leaves, straw, etc.) must be removed regularly. If flammable debris is allowed to accumulate, it will increase fire hazard. Clean often to avoid this accumulation. Flammable debris in the engine compartment is a potential hazard.

The spark arrestor muffler is designed to control the emission of hot particles from the engine and exhaust system, but the muffler and the exhaust gases are still hot.

- Do not use the machine where exhaust, arcs, sparks or hot components can contact flammable material, explosive dust or gases.
- The operator cab, engine compartment, and engine cooling system must be inspected every day and cleaned if necessary to prevent fire hazard and overheating.
- Check all electrical wiring and connections for damage. Keep the battery terminals clean and tight. Repair or replace any damaged part.
- Check fuel and hydraulic tubes, hoses and fittings for damage and leakage. Never use open flame or bare skin to check for leaks. Tighten or replace any parts that show leakage. Always clean fluid spills. Do not use gasoline or diesel fuel for cleaning parts. Use commercial nonflammable solvents.
- Do not use ether or starting fluids on any engine which has glow plugs. These starting aids can cause explosion and injure you or bystanders.
- Always clean the machine, disconnect the battery, and disconnect the wiring from the controllers before welding. Cover rubber hoses, battery and all other flammable parts. Keep a fire extinguisher near the machine when welding. Have good ventilation when grinding or welding painted parts. Wear a dust mask when grinding painted parts. Toxic dust or gas can be produced.
- Stop the engine and let it cool before adding fuel. **NO SMOKING!**

- Use the procedure in the Operation & Maintenance Manual for connecting the battery and for jump starting.
- Use the procedure in the Operation & Maintenance Manual for cleaning the spark arrestor muffler (if equipped).

Figure 1

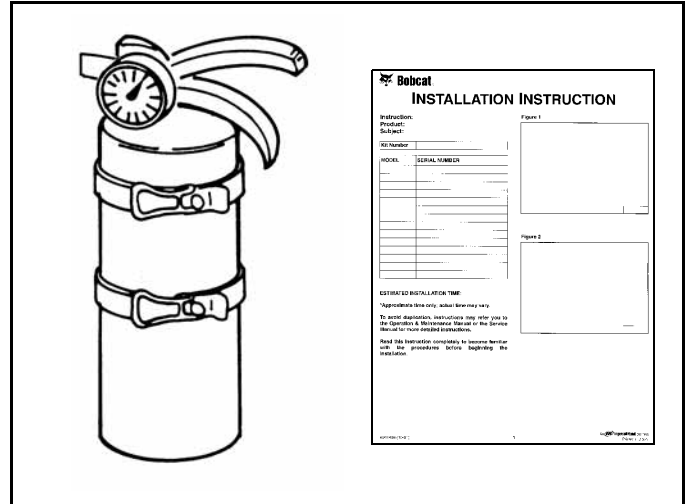

- Know where fire extinguishers and first aid kits are located and how to use them. Fire extinguishers are available from your Bobcat dealer **[Figure 1]**.

## SERIAL NUMBER LOCATIONS

Always use the serial number of the loader when requesting service information or when ordering parts. Early or later models (identification made by serial number) may use different parts, or it may be necessary to use a different procedure in doing a specific service operation.

**Figure 1**

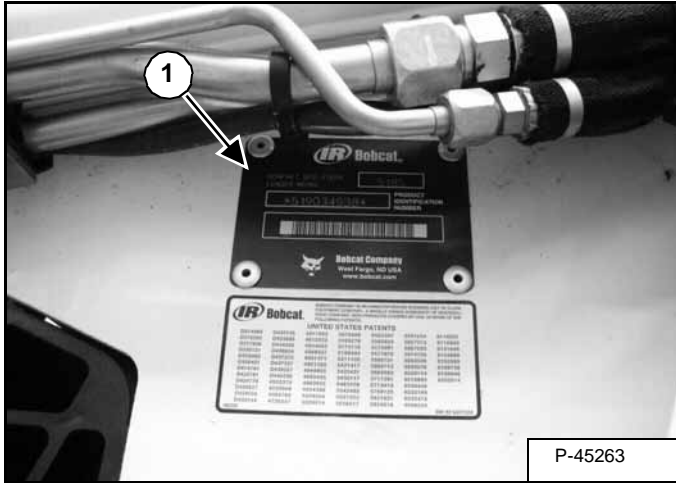

### Loader Serial Number

The loader serial number plate is located on the outside of the loader frame [Figure 1].

Explanation of loader Serial Number:

XXXX XXXXX

Module 2. - Production  
Sequence (Series)

Module 1. - Model / Engine  
Combination

1. The four digit Model/Engine Combination Module number identifies the model number and engine combination.

2. The five digit Production Sequence Number identifies the order which the loader is produced.

### Engine Serial Number

**Figure 2**

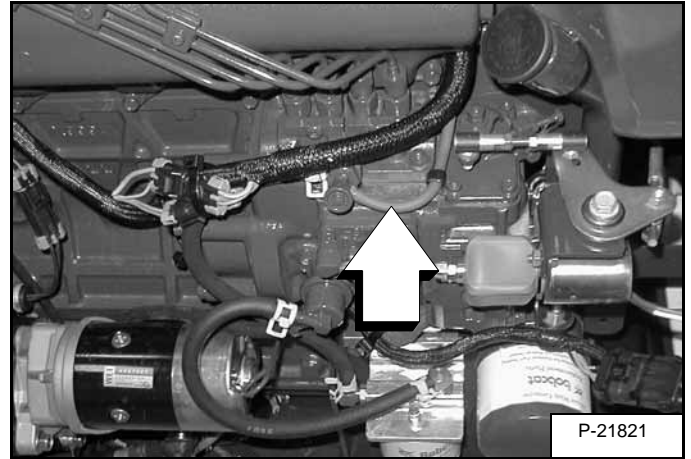

The engine serial number is located on the side of the engine [Figure 2].

## DELIVERY REPORT

Figure 3

The diagram shows a form layout with the following sections:

- Top right: A box titled "DELIVERY REPORT" with several horizontal lines for text.
- Top left: A section with several horizontal lines.
- Middle left: A box titled "WARNING" with several horizontal lines below it.
- Middle right: A large section with many horizontal lines.
- Bottom right: A small box containing the text "B-16315".

The delivery report must be filled out by the dealer and signed by the owner or operator when the Bobcat loader is delivered. An explanation of the form must be given to the owner. Make sure it is filled out completely **[Figure 3]**.

# BOBCAT LOADER IDENTIFICATION

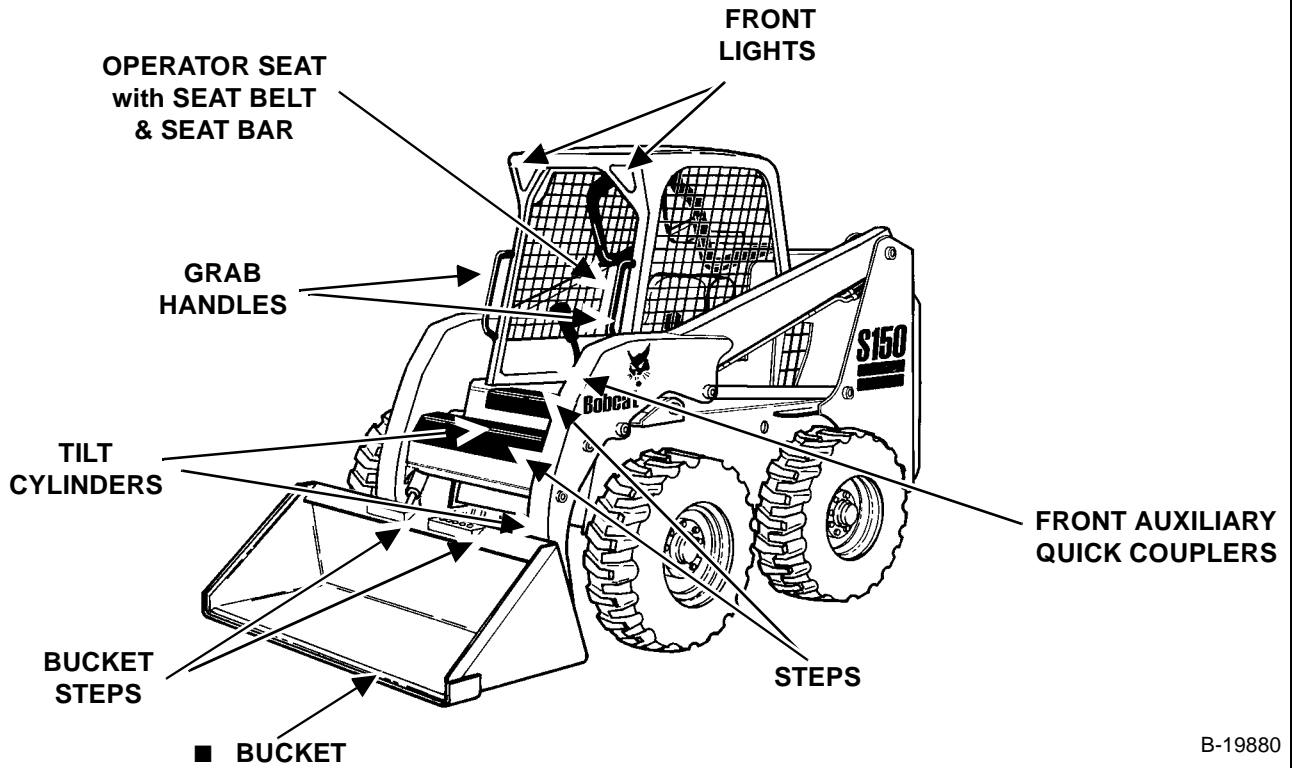

B-19880

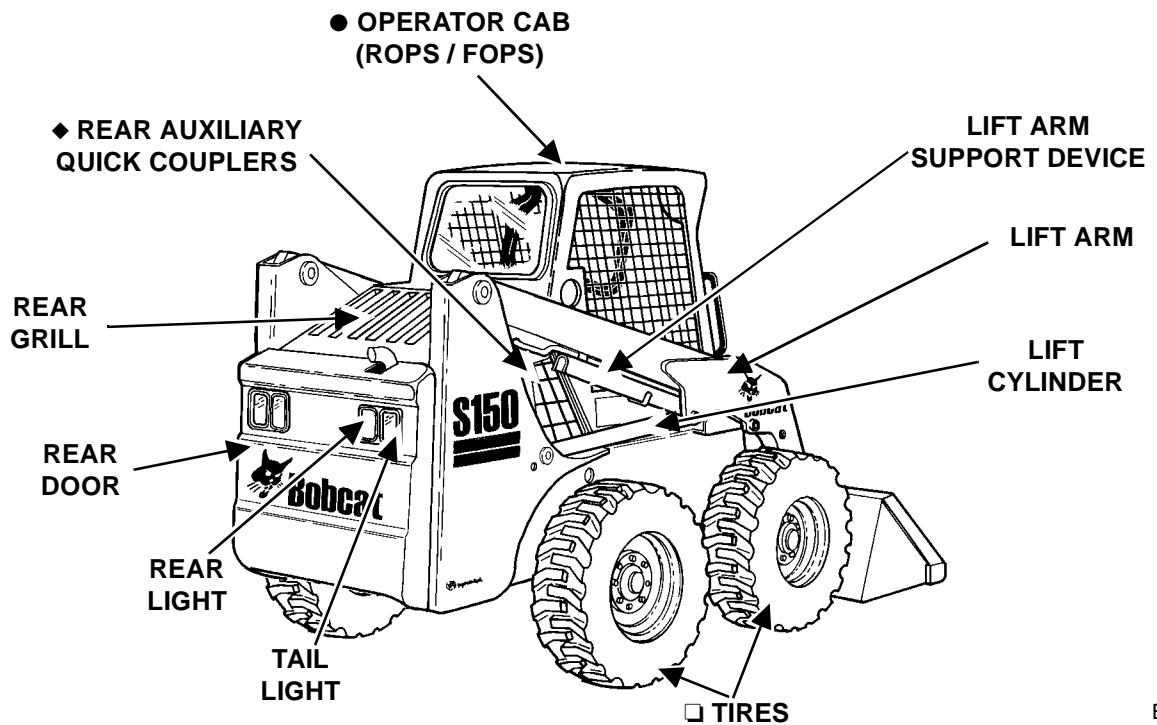

B-19881

◆ Optional or Field Accessory (Not Standard Equipment)

□ TIRES - Tires shown may not be standard. The machine is factory equipped with standard tires. Other tires are available.

■ Bucket - Several different buckets and other attachments are available for this machine.

● ROPS, FOPS - Roll Over Protective Structure, per SAE J1040 and ISO 3471, and Falling Object Protective Structure per SAE J1043 and ISO 3449, Level I. Level II is available.

AIR CLEANER SERVICE .....	10-80-1
Checking .....	10-80-1
Replacing Filter Element(s) .....	10-80-1
BOB-TACH .....	10-150-1
Inspection And Maintenance .....	10-150-1
ENGINE COOLING SYSTEM .....	10-90-1
Checking The Coolant Level .....	10-90-2
Cleaning The Cooling System .....	10-90-1
Replacing the Coolant .....	10-90-2
ENGINE LUBRICATION SYSTEM .....	10-110-1
Checking Engine Oil .....	10-110-1
Oil Chart .....	10-110-1
Replacing Oil And Filter .....	10-110-1
FAN GEARBOX .....	10-140-1
Checking And Maintaining .....	10-140-1
FINAL DRIVE TRANSMISSION (CHAINCASE) .....	10-130-1
Checking And Adding Oil .....	10-130-1
Removing Oil From The Chaincase .....	10-130-1
FUEL SYSTEM .....	10-100-1
Filling The Fuel Tank .....	10-100-1
Fuel Filter .....	10-100-2
Fuel Specifications .....	10-100-1
Removing Air From The Fuel System .....	10-100-2
HYDRAULIC/HYDROSTATIC SYSTEM .....	10-120-1
Breather Cap .....	10-120-3
Checking And Adding Fluid .....	10-120-1
Replacing Hydraulic Fluid .....	10-120-1
Replacing Hydraulic/Hydrostatic Filter .....	10-120-1
LIFT ARM SUPPORT DEVICE .....	10-20-1
Installing Lift Arm Support Device .....	10-20-1
Removing Lift Arm Support Device .....	10-20-2
LIFTING AND BLOCKING THE LOADER .....	10-10-1
Procedure .....	10-10-1
LUBRICATION OF THE BOBCAT LOADER .....	10-160-1
Procedure .....	10-160-1

Continued On Next Page

## SAFETY AND MAINTENANCE (CONT'D)

OPERATOR CAB .....	10-30-1
Description .....	10-30-1
Emergency Exit .....	10-30-3
Lowering The Operator Cab .....	10-30-2
Raising The Operator Cab .....	10-30-1
POWER BOB-TACH (OPTION) .....	10-151-1
Inspection And Maintenance .....	10-151-1
REMOTE START .....	10-60-1
Procedure .....	10-60-1
SERVICE SCHEDULE .....	10-70-1
Chart .....	10-70-1
SPARK ARRESTOR MUFFLER .....	10-180-1
Cleaning Procedure .....	10-180-1
TIRE MAINTENANCE .....	10-170-1
Mounting .....	10-170-1
Rotating .....	10-170-1
Wheel Nuts .....	10-170-1
TOWING THE LOADER .....	10-50-1
Procedure .....	10-50-1
TRANSPORTING THE BOBCAT LOADER .....	10-40-1
Procedure .....	10-40-1

## LIFTING AND BLOCKING THE LOADER

Figure 10-10-1

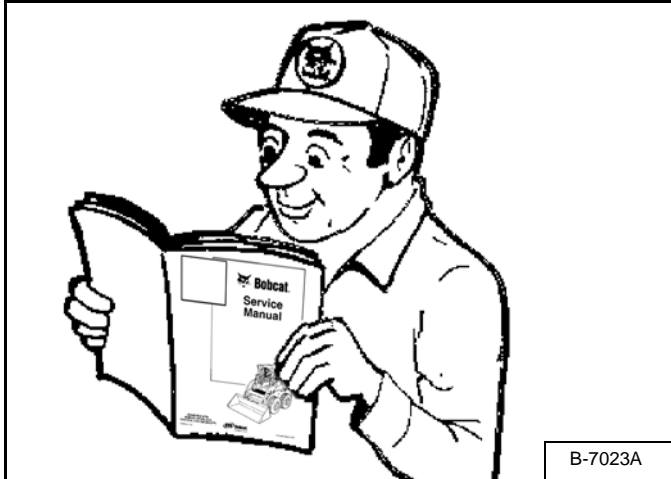

### **WARNING**

Instructions are necessary before operating or servicing machine. Read and understand the Operation & Maintenance Manual, Handbook and signs (decals) on machine. Follow warnings and instructions in the manuals when making repairs, adjustments or servicing. Check for correct function after adjustments, repairs or service. Untrained operators and failure to follow instructions can cause injury or death.

W-2003-0199

#### Procedure

Always park the loader on a level surface.

### **WARNING**

Put jackstands under the front axles and rear corners of the frame before running the engine for service. Failure to use jackstands can allow the machine to fall or move and cause injury or death.

W-2017-0286

Figure 10-10-2



Put a floor jack under the rear of the loader.

Lift the rear of the loader and install jackstands [Figure 10-10-2].

Figure 10-10-3



Put the floor jack under the front of the loader.

Lift the front of the loader and put jackstands under the axle tubes [Figure 10-10-3].

**NOTE:** Make sure the jackstands do not touch the tires. Make sure tires clear the floor and any obstacles.

## LIFT ARM SUPPORT DEVICE

### Installing Lift Arm Support Device

# ⚠ WARNING

Never work on a machine with the lift arms up unless the lift arms are secured by an approved lift arm support device. Failure to use an approved lift arm support device can allow the lift arms or attachment to fall and cause injury or death.

W-2059-0598

# ⚠ WARNING

Service lift arm support device if damaged or if parts are missing. Using a damaged lift arm support or with missing parts can cause lift arms to drop causing injury or death.

W-2271-1197

<h2>⚠ DANGER</h2> <p><b>AVOID DEATH</b></p> <ul style="list-style-type: none"><li>• Disconnecting or loosening any hydraulic tubeline, hose, fitting, component or a part failure can cause lift arms to drop.</li><li>• Keep out of this area when lift arms are raised unless supported by an approved lift arm support. Replace if damaged. 57051</li></ul>	 <p>SW 02 6717343</p>
--	---

Figure 10-20-1



Put jackstands under the rear corners of the loader frame (Inset) [Figure 10-20-1].

Disconnect the spring from the lift arm support device retaining pin (Item 1). Support the lift arm support device (Item 2) [Figure 10-20-1] with your hand and remove the retaining pin.

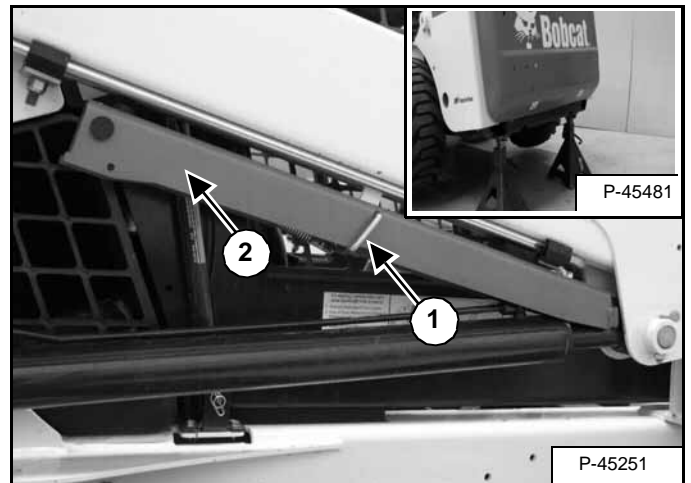
Figure 10-20-2

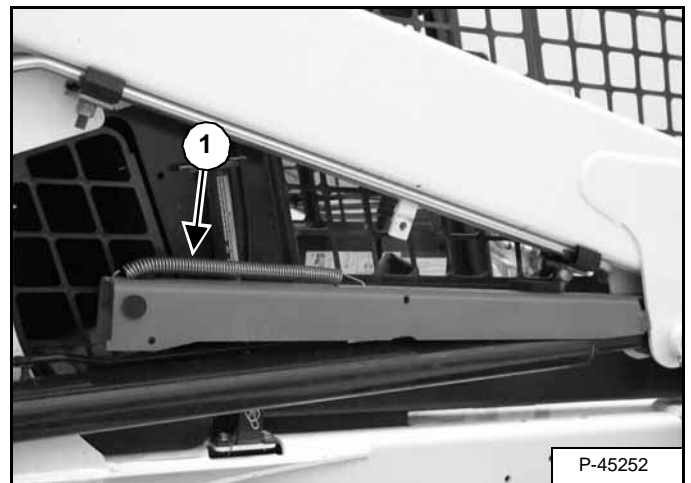

Lower the lift arm support device on top of the lift cylinder. Hook the free end of the spring (Item 1) [Figure 10-20-2] to the lift arm support device so there will be no interference with the support device engagement.

The operator must be in the operator's seat, with the seat belt fastened and seat bar lowered.

Start the engine, and raise the lift arms all the way up.



## LIFT ARM SUPPORT DEVICE (CONT'D)

### Installing Lift Arm Support Device (Cont'd)

Figure 10-20-3

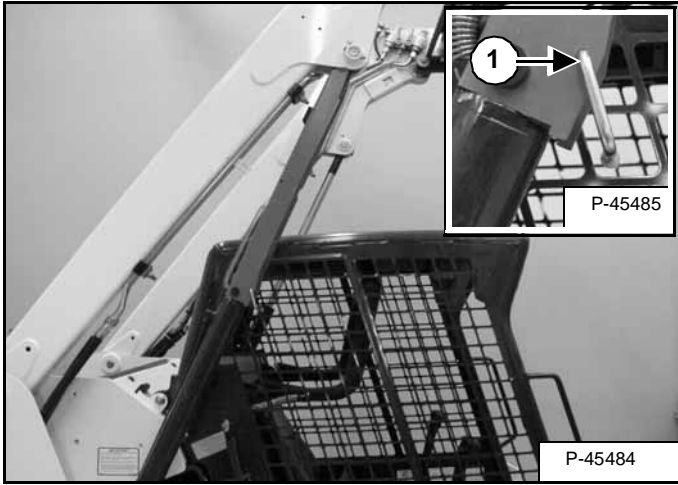

Raise the lift arms until the lift arm support device drops onto the lift cylinder rod [Figure 10-20-3].

Lower the lift arms slowly until the lift arm support device is held between the lift arms and lift cylinder [Figure 10-20-3]. Stop the engine. Raise the seat bar, and move both the pedals until both pedals lock.

Install pin (Item 1) (Inset) [Figure 10-20-3].

**NOTE:** The lift arm support device must be tight against the cylinder rod. The tabs of the lift arm support device must be under the cylinder as shown (Inset) [Figure 10-20-3].

## Removing Lift Arm Support Device

Figure 10-20-4

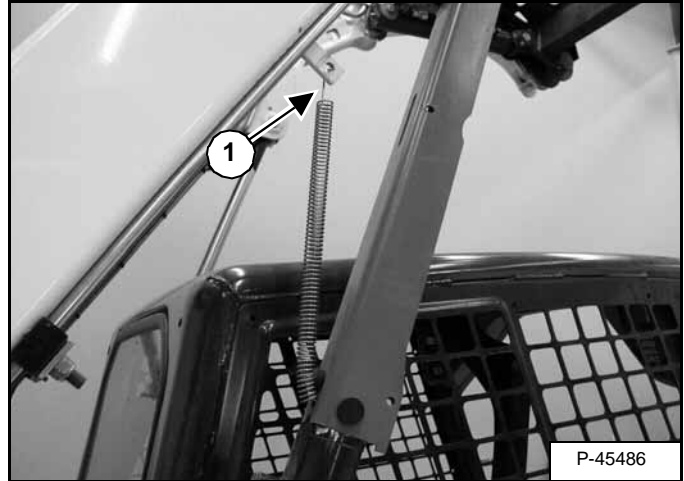

Remove the pin from the lift arm support device.

Connect the spring (Item 1) [Figure 10-20-4] from the lift arm support device to the bracket below the lift arms.

The operator must be in the operator's seat, with the seat belt fastened and seat bar lowered, until the lift arm support device is removed and the lift arms are lowered all the way.

Start the engine, raise the lift arms all the way up. The spring will lift the support device off the lift cylinder rod.

Lower the lift arms all the way and stop the engine.

Raise the seat bar and move the pedals until both pedals lock.

Disconnect the spring from the bracket.

Figure 10-20-5

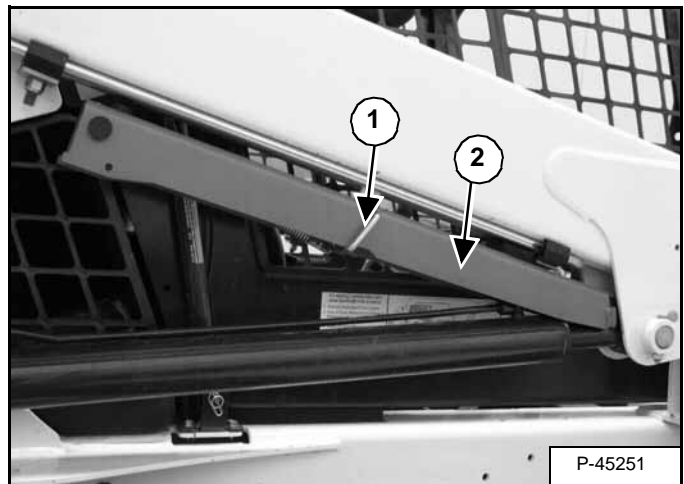

Return the lift arm support device to storage position and insert pin (Item 1) through lift arm support device (Item 2) [Figure 10-20-5] and welded tab on boom. Connect spring to pin.

Remove the jackstands.

**Thank you very much  
for your reading.**

**Please click here and go  
back to the website.**

**Then, you can  
download the complete  
manual instantly.**

**No waiting.**