



OWNER'S SERVICE MANUAL

YZ450FR

LIT-11626-16-38

5TA-28199-10

INTRODUCTION

Congratulations on your purchase of a Yamaha YZ series. This model is the culmination of Yamaha's vast experience in the production of pacesetting racing machines. It represents the highest grade of craftsmanship and reliability that have made Yamaha a leader.

This manual explains operation, inspection, basic maintenance and tuning of your machine. If you have any questions about this manual or your machine, please contact your Yamaha dealer.

NOTE:

As improvements are made on this model, some data in this manual may become outdated. If you have any questions, please consult your Yamaha dealer.

⚠ WARNING

PLEASE READ THIS MANUAL CAREFULLY AND COMPLETELY BEFORE OPERATING THIS MACHINE. DO NOT ATTEMPT TO OPERATE THIS MACHINE UNTIL YOU HAVE ATTAINED A SATISFACTORY KNOWLEDGE OF ITS CONTROLS AND OPERATING FEATURES AND UNTIL YOU HAVE BEEN TRAINED IN SAFE AND PROPER RIDING TECHNIQUES. REGULAR INSPECTIONS AND CAREFUL MAINTENANCE, ALONG WITH GOOD RIDING SKILLS, WILL ENSURE THAT YOU SAFELY ENJOY THE CAPABILITIES AND THE RELIABILITY OF THIS MACHINE.

EC030002
YAMAHA MOTOR CORPORATION, U.S.A.
YZ/WR MOTORCYCLE LIMITED WARRANTY

Yamaha Motor Corporation, U.S.A. hereby warrants to the original retail purchaser that the following components equipped on new Yamaha YZ or WR motorcycles purchased from an authorized Yamaha motorcycle dealer in the continental United States will be free from defects in material and workmanship for the period of time stated herein, subject to certain stated limitations. YZ or WR components included under this warranty are the engine, frame, swingarm, and monoshock. It is understood that the balance of the YZ or WR components are not covered by any warranty, expressed or implied. The balance of the components equipped on the unit are sold on an "as is" basis. This warranty applies to the original purchaser only and is not transferable.

THE PERIOD OF WARRANTY for the above-listed Yamaha YZ or WR components as originally installed on the unit shall be thirty (30) days from the date of purchase.

MODELS EXCLUDED FROM WARRANTY include those used for non-Yamaha-authorized renting, leasing, or other commercial purposes.

DURING THE PERIOD OF WARRANTY any authorized Yamaha motorcycle dealer will, free of charge, repair or replace, at Yamaha's option, any part adjudged defective by Yamaha due to faulty workmanship or material from the factory. Parts used in warranty repairs will be warranted for the balance of the product's warranty period. All parts replaced under warranty become property of Yamaha Motor Corporation U.S.A.

GENERAL EXCLUSIONS from this warranty shall include any failures caused by:

- a. Installation of parts or accessories that are not qualitatively equivalent to genuine Yamaha parts.
- b. Abnormal strain, neglect, or abuse.
- c. Accident or collision damage.
- d. Modification to original parts.
- e. Lack of proper maintenance.
- f. Damage due to improper transportation.

SPECIFIC EXCLUSIONS from this warranty shall include parts replaced due to normal wear or routine maintenance.

THE CUSTOMER'S RESPONSIBILITY under this warranty shall be to:

1. Operate and maintain the YZ or WR as specified in the appropriate Owner's Service Manual, and
2. Give notice to an authorized Yamaha motorcycle dealer of any and all apparent defects within ten (10) days after discovery, and make the machine available at that time for inspection and repairs at such dealer's place of business.

YAMAHA MOTOR CORPORATION, U.S.A. MAKES NO OTHER WARRANTY OF ANY KIND, EXPRESSED OR IMPLIED. ALL IMPLIED WARRANTIES OF MERCHANTABILITY AND FITNESS FOR A PARTICULAR PURPOSE WHICH EXCEED THE OBLIGATIONS AND TIME LIMITS STATED IN THIS WARRANTY ARE HEREBY DISCLAIMED BY YAMAHA MOTOR CORPORATION, U.S.A. AND EXCLUDED FROM THIS WARRANTY.

SOME STATES DO NOT ALLOW LIMITATIONS ON HOW LONG AN IMPLIED WARRANTY LASTS, SO THE ABOVE

LIMITATION MAY NOT APPLY TO YOU. ALSO EXCLUDED FROM THIS WARRANTY ARE ANY INCIDENTAL OR CONSEQUENTIAL DAMAGES INCLUDING LOSS OF USE. SOME STATES DO NOT ALLOW THE EXCLUSION OR LIMITATION OF INCIDENTAL OR CONSEQUENTIAL DAMAGES, SO THE ABOVE EXCLUSION MAY NOT APPLY TO YOU.

THIS WARRANTY GIVES YOU SPECIFIC LEGAL RIGHTS, AND YOU MAY ALSO HAVE OTHER RIGHTS WHICH VARY FROM STATE TO STATE.

YAMAHA MOTOR CORPORATION, U.S.A.
Post Office Box 6555
Cypress, California 90630

WARRANTY QUESTIONS AND ANSWERS

- Q. What costs are my responsibility during the warranty period?
- A. The customer's responsibility includes all costs of normal maintenance services, non-warranty repairs, accident and collision damage, and oil, oil filters, air filters, spark plugs, and brake shoes or pads.
- Q. What are some examples of "abnormal" strain, neglect, or abuse?
- A. These terms are general and overlap each other in areas. Specific examples include: Running the machine without oil; operating the machine with a broken or damaged part which causes another part to fail, damage or failure due to improper or careless transportation and or tie down; and so on. If you have any specific questions on operation or maintenance, please contact your dealer for advice.
- Q. Does the warranty cover incidental costs such as towing or transportation due to a failure?
- A. No. The warranty is limited to repair of the machine itself.
- Q. May I perform any or all of the recommended maintenance shown in the Owner's Service Manual instead of having the dealer do them?
- A. Yes, if you are a qualified mechanic and follow the procedures specified in the Owner's Service Manual. We do recommend, however, that items requiring special tools or equipment be done by a Yamaha motorcycle dealer.
- Q. Will the warranty be void or canceled if I do not operate or maintain my new YZ or WR exactly as specified in the Owner's Service Manual?
- A. No. The warranty on a new motorcycle cannot be "voided" or "cancelled." **However, if a particular failure is caused by operation or maintenance other than as shown in the Owner's Service Manual, that failure may not be covered under warranty.**
- Q. What responsibility does my dealer have under this warranty?
- A. Each Yamaha motorcycle dealer is expected to:
1. Completely set up every new machine before sale.
 2. Explain the operation, maintenance, and warranty requirements to your satisfaction at the time of sale, and upon your request at any later date.
In addition, each Yamaha motorcycle dealer is held responsible for his setup, service and warranty repair work.
- Q. Does the warranty on the engine include the carburetor, air filter, air box, and exhaust pipe?
- A. No. The warranty covers only the engine components.

CUSTOMER SERVICE

If your machine requires warranty service, you must take it to any authorized Yamaha motorcycle dealer within the continental United States. Be sure to bring your warranty registration identification or other valid proof of the original date of purchase. If a question or problem arises regarding warranty, first contact the owner of the dealer-ship. Since all warranty matters are handled at the dealer level, this person is in the best position to help you. If you are still not satisfied and require additional assistance, please write:

YAMAHA MOTOR CORPORATION U.S.A.
CUSTOMER RELATIONS DEPARTMENT
P.O. Box 6555
Cypress, California 90630

When contacting Yamaha Motor Corporation, U.S.A. don't forget to include any important information such as names, addresses, model, V.I.N. (frame number), dates, and receipts.

CHANGE OF ADDRESS

The federal government requires each manufacturer of a motor vehicle to maintain a complete, up-to-date list of all first purchasers against the possibility of a safety-related defect and recall. This list is compiled from the purchase registrations sent to Yamaha Motor Corporation, U.S.A. by the selling dealer at the time of your purchase.

If you should move after you have purchased your new motorcycle, please advise us of your new address by sending a postcard listing your motorcycle model name, V.I.N. (frame number), dealer number (or dealer's name) as it is shown on your warranty identification, your name and new mailing address. Mail to:

YAMAHA MOTOR CORPORATION, U.S.A.
WARRANTY DEPARTMENT
P.O.Box 6555
Cypress, California 90630

This will ensure that Yamaha Motor Corporation, U.S.A. has an up-to-date registration record in accordance with federal law.

IMPORTANT NOTICE

THIS MACHINE IS DESIGNED STRICTLY FOR COMPETITION USE, ONLY ON A CLOSED COURSE. It is illegal for this machine to be operated on any public street, road, or highway. Off-road use on public lands may also be illegal. Please check local regulations before riding.

⚠ SAFETY INFORMATION

- 1. THIS MACHINE IS TO BE OPERATED BY AN EXPERIENCED RIDER ONLY.**
Do not attempt to operate this machine at maximum power until you are totally familiar with its characteristics.
- 2. THIS MACHINE IS DESIGNED TO BE RIDDEN BY THE OPERATOR ONLY.**
Do not carry passengers on this machine.
- 3. ALWAYS WEAR PROTECTIVE APPAREL.**
When operating this machine, always wear an approved helmet with goggles or a face shield. Also wear heavy boots, gloves, and protective clothing. Always wear proper fitting clothing that will not be caught in any of the moving parts or controls of the machine.
- 4. ALWAYS MAINTAIN YOUR MACHINE IN PROPER WORKING ORDER.**
For safety and reliability, the machine must be properly maintained. Always perform the pre-operation checks indicated in this manual. Correcting a mechanical problem before you ride may prevent an accident.
- 5. GASOLINE IS HIGHLY FLAMMABLE.**
Always turn off the engine while refueling. Take care to not spill any gasoline on the engine or exhaust system. Never refuel in the vicinity of an open flame, or while smoking.

6. GASOLINE CAN CAUSE INJURY.

If you should swallow some gasoline, inhale excess gasoline vapors, or allow any gasoline to get into your eyes, contact a doctor immediately. If any gasoline spills onto your skin or clothing, immediately wash skin areas with soap and water, and change your clothes.

7. ONLY OPERATE THE MACHINE IN AN AREA WITH ADEQUATE VENTILATION.

Never start the engine or let it run for any length of time in an enclosed area. Exhaust fumes are poisonous. These fumes contain carbon monoxide, which by itself is odorless and colorless. Carbon monoxide is a dangerous gas which can cause unconsciousness or can be lethal.

8. PARK THE MACHINE CAREFULLY; TURN OFF THE ENGINE.

Always turn off the engine if you are going to leave the machine. Do not park the machine on a slope or soft ground as it may fall over.

9. THE ENGINE, EXHAUST PIPE, MUFFLER, AND OIL TANK WILL BE VERY HOT AFTER THE ENGINE HAS BEEN RUN.

Be careful not to touch them or to allow any clothing item to contact them during inspection or repair.

10. PROPERLY SECURE THE MACHINE BEFORE TRANSPORTING IT.

When transporting the machine in another vehicle, always be sure it is properly secured and in an upright position and that the fuel cock is in the "OFF" position. Otherwise, fuel may leak out of the carburetor or fuel tank.

EC050000

TO THE NEW OWNER

This manual will provide you with a good basic understanding of features, operation, and basic maintenance and inspection items of this machine. Please read this manual carefully and completely before operating your new machine. If you have any questions regarding the operation or maintenance of your machine, please consult your Yamaha dealer.

NOTE: _____

This manual should be considered a permanent part of this machine and should remain with it even if the machine is subsequently sold.

EC060000

NOTICE

Some data in this manual may become outdated due to improvements made to this model in the future. If there is any question you have regarding this manual or your machine, please consult your Yamaha dealer.

EC070001

F.I.M. MACHINE WEIGHTS: _____

Weights of machines without fuel

The minimum weights for motocross machines are:

for the class 125 cc..... minimum	88 kg (194 lb)
for the class 250 cc..... minimum	98 kg (216 lb)
for the class 500 cc..... minimum	102 kg (225 lb)

In modifying your machine (e.g., for weight reduction), take note of the above limits of weight.

HOW TO USE THIS MANUAL

PARTICULARLY IMPORTANT INFORMATION



The Safety Alert Symbol means ATTENTION! BECOME ALERT! YOUR SAFETY IS INVOLVED!

WARNING

Failure to follow WARNING instructions could result in severe injury or death to the machine operator, a bystander, or a person inspecting or repairing the machine.

CAUTION:

A CAUTION indicates special precautions that must be taken to avoid damage to the machine.

NOTE:

A NOTE provides key information to make procedures easier or clearer.

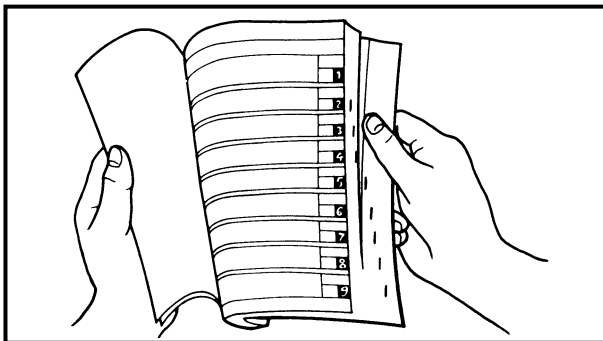

FINDING THE REQUIRED PAGE

1. This manual consists of seven chapters; “General Information”, “Specifications”, “Regular inspection and adjustments”, “Engine”, “Chassis”, “Electrical” and “Tuning”.
2. The table of contents is at the beginning of the manual. Look over the general layout of the book before finding then required chapter and item.

Bend the book at its edge, as shown, to find the required fore edge symbol mark and go to a page for required item and description.

MANUAL FORMAT

All of the procedures in this manual are organized in a sequential, step-by-step format. The information has been compiled to provide the mechanic with an easy to read, handy reference that contains comprehensive explanations of all disassembly, repair, assembly, and inspection operations.

In this revised format, the condition of a faulty component will precede an arrow symbol and the course of action required will follow the symbol, e.g.,

- Bearings
Pitting/damage → Replace.

HOW TO READ DESCRIPTIONS

To help identify parts and clarify procedure steps, there are exploded diagrams at the start of each removal and disassembly section.

1. An easy-to-see exploded diagram ① is provided for removal and disassembly jobs.
2. Numbers ② are given in the order of the jobs in the exploded diagram. A number that is enclosed by a circle indicates a disassembly step.
3. An explanation of jobs and notes is presented in an easy-to-read way by the use of symbol marks ③. The meanings of the symbol marks are given on the next page.
4. A job instruction chart ④ accompanies the exploded diagram, providing the order of jobs, names of parts, notes in jobs, etc.
5. Extent of removal ⑤ is provided in the job instruction chart to save the trouble of an unnecessary removal job.
6. For jobs requiring more information, the step-by-step format supplements ⑥ are given in addition to the exploded diagram and job instruction chart.

CLUTCH REMOVAL

Extent of removal:

- ① Push rod and push lever removal
- ② Push pod 1 disassembly
- ③ Friction plate and clutch plate removal
- ④ Clutch housing removal

Extent of removal	Order	Part name	Qty	Remarks
Preparation for removal		CLUTCH REMOVAL		Refer to "ENGINE OIL REPLACEMENT" section in the CHAPTER 3.
		Drain the engine oil.		Refer to "ENGINE REMOVAL" section.
		Brake pedal Clutch cable		Disconnect at engine side.
⑤	1	Clutch cover	1	
	2	Gasket	1	
	3	Dowel pin	2	
	4	Clutch spring	6	
	5	Pressure plate	1	
	6	Push rod 1	1	
	7	Circlip	1	
	8	Plain washer	1	
	9	Bearing	1	
	10	Ball	1	
	11	Push rod 2	1	

REMOVAL POINTS

Clutch boss

- Remove:
 - Nut ①
 - Lock washer ②
 - Clutch boss ③

NOTE:
Straighten the lock washer tab and use the clutch holding tool ④ to hold the clutch boss.

Clutch holding tool:
YM-91042/90890-04086

Ⓐ For USA and CDN
Ⓑ Except for USA and CDN

INSPECTION

Clutch housing and boss

- Inspect:
 - Clutch housing ①
Cracks/wear/damage → Replace.
 - Clutch boss ②
Scoring/wear/damage → Replace.

Primary driven gear

- Check:
 - Circumferential play
Free play exists → Replace.
 - Gear teeth ③
Wear/damage → Replace.















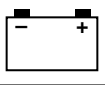

Clutch spring

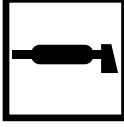
- Measure:
 - Clutch spring free length ④
Out of specification → Replace springs as a set.

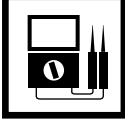
Clutch spring free length:	
Standard	<Limit>
50 mm (1.97 in)	49 mm (1.93 in)

4 - 48

4 - 50

① GEN INFO 	② SPEC 
③ INSP ADJ 	④ ENG 
⑤ CHAS 	⑥ ELEC 
⑦ TUN 	⑧ 
⑨ 	⑩ 
⑪ 	⑫ 
⑬ 	⑭ 
⑮ 	⑯ 
⑰ 	⑱ 
⑲ 	⑳ New

ILLUSTRATED SYMBOLS (Refer to the illustration)

Illustrated symbols ① to ⑦ are designed as thumb tabs to indicate the chapter's number and content.

- ① General information
- ② Specifications
- ③ Regular inspection and adjustments
- ④ Engine
- ⑤ Chassis
- ⑥ Electrical
- ⑦ Tuning

Illustrated symbols ⑧ to ⑭ are used to identify the specifications appearing in the text.

- ⑧ With engine mounted
- ⑨ Special tool
- ⑩ Filling fluid
- ⑪ Lubricant
- ⑫ Tightening
- ⑬ Specified value, Service limit
- ⑭ Resistance (Ω), Voltage (V), Electric current (A)

Illustrated symbols ⑮ to ⑱ in the exploded diagrams indicate grade of lubricant and location of lubrication point.







- ⑮ Apply engine oil
- ⑯ Apply molybdenum disulfide oil
- ⑰ Apply lightweight lithium-soap base grease
- ⑱ Apply molybdenum disulfide grease

Illustrated symbols ⑲ to ⑳ in the exploded diagrams indicate where to apply a locking agent and where to install new parts.

- ⑲ Apply locking agent (LOCTITE®)
- ⑳ Use new one

MEMO

INDEX

GENERAL INFORMATION	
	GEN INFO 1
SPECIFICATIONS	
	SPEC 2
REGULAR INSPECTION AND ADJUSTMENTS	
	INSP ADJ 3
ENGINE	
	ENG 4
CHASSIS	
	CHAS 5
ELECTRICAL	
	ELEC 6
TUNING	
	TUN 7

CONTENTS

CHAPTER 1 GENERAL INFORMATION

DESCRIPTION	1-1
MACHINE IDENTIFICATION	1-2
IMPORTANT INFORMATION	1-3
CHECKING OF CONNECTION	1-6
SPECIAL TOOLS	1-7
CONTROL FUNCTIONS	1-10
FUEL	1-13
STARTING AND BREAK-IN	1-14
TORQUE-CHECK POINTS	1-18
CLEANING AND STORAGE	1-19

CHAPTER 2 SPECIFICATIONS

GENERAL SPECIFICATIONS	2-1
MAINTENANCE SPECIFICATIONS	2-4
GENERAL TORQUE SPECIFICATIONS	2-18
DEFINITION OF UNITS	2-18
LUBRICATION DIAGRAMS	2-19
CABLE ROUTING DIAGRAM	2-21

CHAPTER 3 REGULAR INSPECTION AND ADJUSTMENTS

MAINTENANCE INTERVALS	3-1
PRE-OPERATION INSPECTION AND MAINTENANCE	3-4
ENGINE	3-5
CHASSIS	3-24
ELECTRICAL	3-45

CHAPTER 4 ENGINE

SEAT, FUEL TANK AND SIDE COVERS	4-1
EXHAUST PIPE AND SILENCER	4-3
RADIATOR	4-5
CARBURETOR	4-8
CAMSHAFTS	4-21
CYLINDER HEAD	4-29
VALVES AND VALVE SPRINGS	4-33
CYLINDER AND PISTON	4-42
CLUTCH	4-48
OIL FILTER, WATER PUMP AND CRANKCASE COVER (RIGHT)	4-55
BALANCER	4-62
OIL PUMP	4-65
KICK AXLE AND SHIFT SHAFT	4-69
CDI MAGNETO	4-76
ENGINE REMOVAL	4-80
CRANKCASE AND CRANKSHAFT	4-85
TRANSMISSION, SHIFT CAM AND SHIFT FORK	4-94

CHAPTER 5 CHASSIS

FRONT WHEEL AND REAR WHEEL	5-1
FRONT BRAKE AND REAR BRAKE	5-10
FRONT FORK	5-26
HANDLEBAR	5-39
STEERING	5-45
SWINGARM	5-50
REAR SHOCK ABSORBER	5-58

CHAPTER 6 ELECTRICAL

ELECTRICAL COMPONENTS AND WIRING DIAGRAM	6-1
MAP-CONTROLLED CDI UNIT	6-2
IGNITION SYSTEM	6-3
TPS (THROTTLE POSITION SENSOR) SYSTEM	6-7

CHAPTER 7 TUNING

ENGINE	7-1
CHASSIS	7-10

EC100000

GENERAL INFORMATION

EC110000

DESCRIPTION

- ① Clutch lever
- ② Hot starter lever
- ③ Front brake lever
- ④ Throttle grip
- ⑤ Radiator cap
- ⑥ Fuel tank cap
- ⑦ "ENGINE STOP" button
- ⑧ Kick starter
- ⑨ Fuel tank
- ⑩ Radiator
- ⑪ Coolant drain bolt
- ⑫ Rear brake pedal
- ⑬ Valve joint
- ⑭ Fuel cock
- ⑮ Cold starter knob
- ⑯ Drive chain
- ⑰ Air cleaner
- ⑱ Shift pedal
- ⑲ Oil dipstick
- ⑳ Front fork

NOTE:

- The machine you have purchased may differ slightly from those shown in the following.
- Designs and specifications are subject to change without notice.

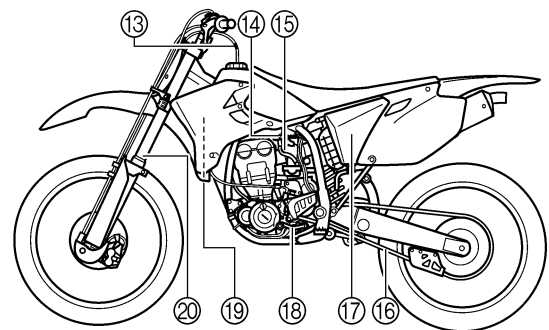
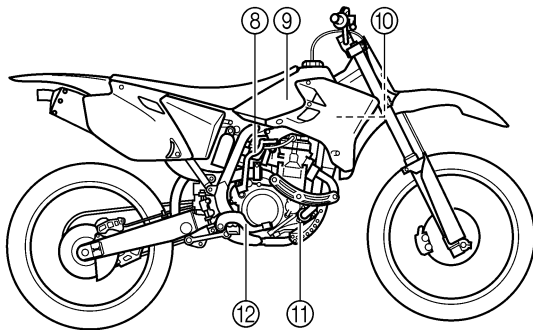
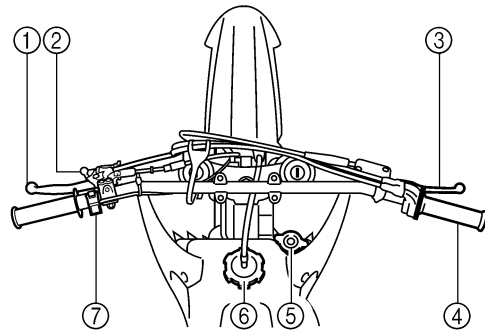
**1**

EC120001

MACHINE IDENTIFICATION

There are two significant reasons for knowing the serial number of your machine:

1. When ordering parts, you can give the number to your Yamaha dealer for positive identification of the model you own.
2. If your machine is stolen, the authorities will need the number to search for and identify your machine.

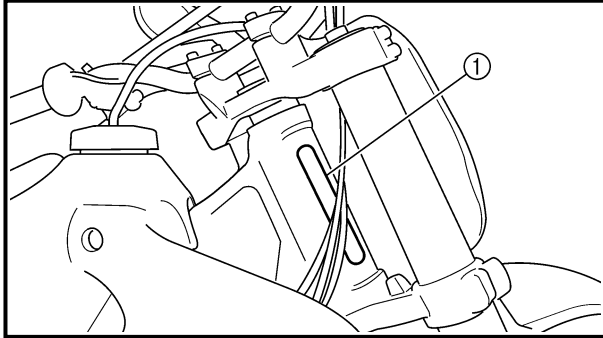

EC121001

VEHICLE IDENTIFICATION NUMBER

The vehicle identification number ① is stamped on the right of the steering head pipe.

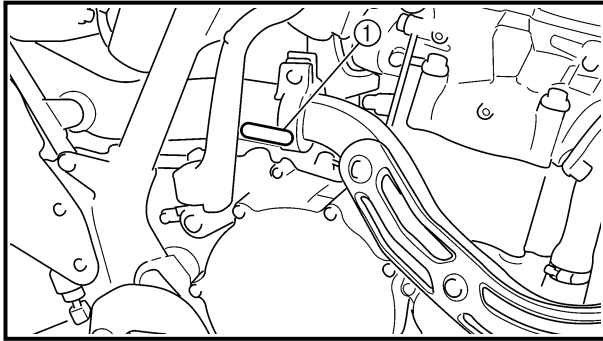

EC123001

ENGINE SERIAL NUMBER

The engine serial number ① is stamped into the elevated part of the right-side of the engine.

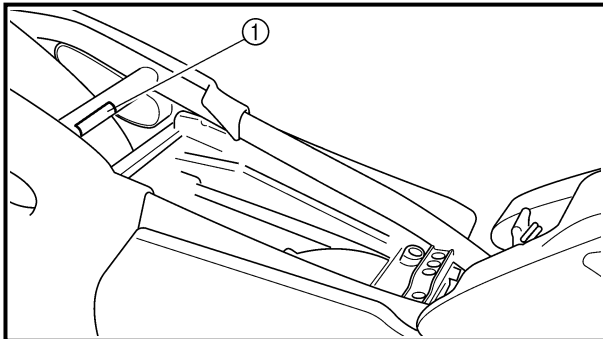

EC124000

MODEL LABEL

The model label ① is affixed to the frame under the rider's seat. This information will be needed to order spare parts.



EC130000

IMPORTANT INFORMATION

EC131010

PREPARATION FOR REMOVAL AND DISASSEMBLY

1. Remove all dirt, mud, dust, and foreign material before removal and disassembly.

When washing the machine with high pressured water, cover the parts as follows.

- Silencer exhaust port
- Side cover air intake port
- Water pump housing hole at the bottom
- Drain hole on the cylinder head (right side)

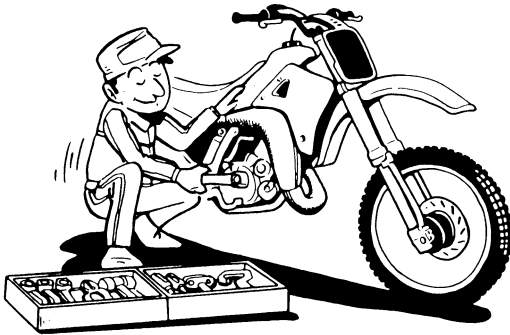
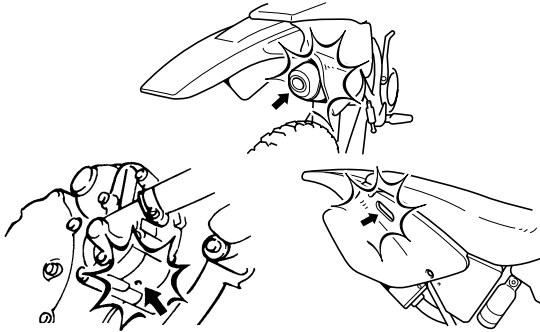

2. Use proper tools and cleaning equipment. Refer to "SPECIAL TOOLS" section.

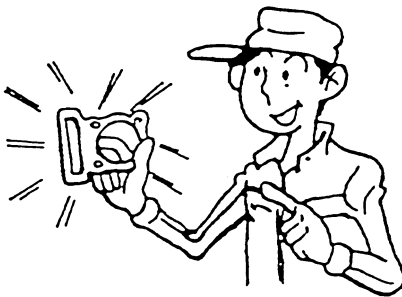

3. When disassembling the machine, keep mated parts together. They include gears, cylinders, pistons, and other mated parts that have been "mated" through normal wear. Mated parts must be reused as an assembly or replaced.

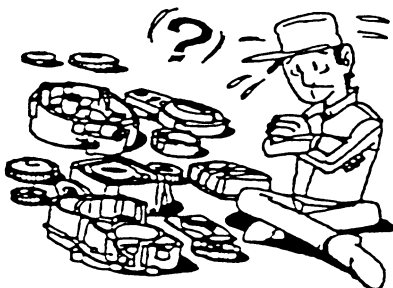

4. During the machine disassembly, clean all parts and place them in trays in the order of disassembly. This will speed up assembly time and help assure that all parts are correctly reinstalled.

5. Keep away from fire.

**Thank you very much
for your reading.**

**Please click here and go
back to the website.**

**Then, you can
download the complete
manual instantly.**

No waiting.